

# *S and S Firearms*

*Purveyors of Military Americana*

*Established 1957*

**74-11 MYRTLE AVENUE, GLENDALE, NEW YORK 11385**

**Telephone 718-497-1100 Fax 718-497-1105**

**E-Mail [Info@SSFirearms.com](mailto:Info@SSFirearms.com)**

Dear Valued Customers and Friends:

We are proud to present our 54<sup>th</sup> Anniversary Catalog. We appreciate your continued patronage and also welcome you if you are a first time customer. This expanded edition catalog is the largest S & S Firearms has ever produced with over 200 pages full of parts, firearms, clothing, equipment, insignia and items of historical interest.

S & S Firearms was founded in 1957 by Edward P. Siess and his wife, Mary Ann, as an outlet to supply collectors, re-enactors and historians with mail order service for U.S. military items. Mary Ann and son, Phil, are now continuing the business with help from Phil's brother, Ed; wife, Adrienne; and son, Philip.

As a family operated business we have developed long standing business relationships, of which many have grown into friendships. Mary Ann and Adrienne are usually answering the phones and offer a personal touch, gladly assisting you with your order.

It has been said by many that our catalog is useful as a reference guide in addition to being a source for items of the highest quality, both original and reproduction. The 54<sup>th</sup> Anniversary Edition now includes an expanded Shooting Accessory section, reorganized Gun Parts section, and more new items than ever before. We feel this offers a comprehensive source for your needs in the interesting scope of Military Americana – be it for skirmishing, re-enacting, history or collecting.

We attend the Baltimore Arms Collector's Show each March, and both North-South Skirmish Association National shoots at Fort Shenandoah, Winchester, Virginia, in May and October. Meeting and greeting our valued mail order customers personally is always a great pleasure. A small showroom is maintained at the above address and we welcome you to visit.

As mentioned earlier it is a pleasure to serve you, and we look forward to many more years of doing the same.

Sincerely,

*Mary Ann Siess*

Mary Ann Siess

*Philip E. Siess*

Philip E. Siess

*Edward Siess*

Edward G. Siess

*Philip Siess*

Philip J. Siess

*Adrienne Siess*

Adrienne Siess

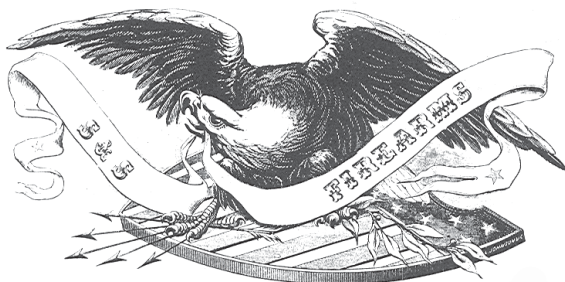

## 1795 SPRINGFIELD

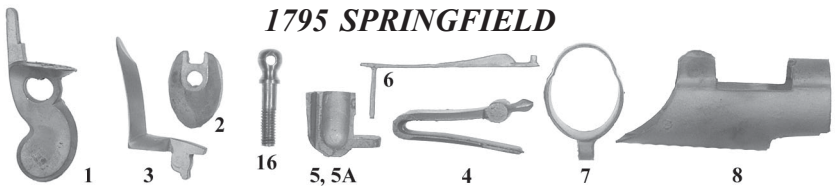

95S1	HAMMER (Reproduction) .....	36.00
95S2	TOP JAW (Reproduction) .....	15.00
16S16	TOP JAW SCREW, 5/16 x 24 Thread (Reproduction) .....	8.50
95S3	FRIZZEN (Reproduction) .....	36.00
95S4	FRIZZEN SPRING (Reproduction) .....	22.00
95S5	PAN, Round Bottom, Weld On. (Reproduction) .....	20.00
95S5A	PAN, Detachable (Reproduction) .....	20.00
95S6	BAND SPRING (Reproduction) .....	16.00
95S7	MIDDLE BAND (Reproduction) .....	30.00
95S8	TOP BAND (Reproduction) .....	38.00

## AUSTRIAN MUSKET



AM101	REAR SIGHT, Single leaf, fits barrel dovetail .....	25.00
AM102	INTERNAL LOCK SCREW .....	4.00
AM103	MAINSRING, Early model (no pin) .....	40.00
AM104	REAR SIGHT, Folding ladder type, complete (Reproduction) .....	115.00
AM110	MAINSRING, Pin Type .....	40.00
AM112	AUSTRIAN FRONT SIGHT, Fits in dovetail (Reproduction) .....	17.00
AM120	AUSTRIAN LORENZ HAMMER SCREWS, Original .....	10.00
AM121	AUSTRIAN LORENZ LOWER BARREL BAND (Reproduction) .....	32.00
AM121A	AUSTRIAN LORENZ LOWER BARREL SPRING (Reproduction) .....	16.00
AM122	AUSTRIAN LORENZ MIDDLE BARREL BAND (Reproduction) .....	38.00
AM122A	AUSTRIAN LORENZ MIDDLE BARREL SPRING (Reproduction) .....	16.00
AM123	AUSTRIAN LORENZ TOP BARREL BAND (Reproduction) .....	47.00
AM123A	AUSTRIAN LORENZ TOP BARREL SPRING (Reproduction) .....	16.00
BKA017	OFFICIAL GOVERNMENT MANUAL, 72 pages, Illustrated, German language .....	9.00

## POTSDAM MUSKET

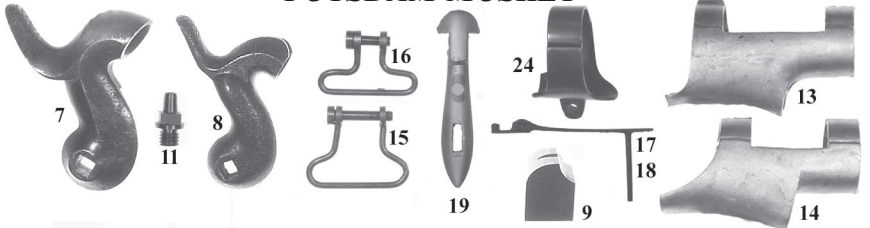

AM107	POTSDAM MUSKET HAMMER .....	65.00
AM108	POTSDAM PISTOL HAMMER .....	50.00
AM109	POTSDAM MUSKET REAR SIGHT, Correct shape with extra material on bottom to be fitted into barrel tang/ breech plug (Reproduction) .....	22.00
AM111	POTSDAM NIPPLE (Reproduction) .....	17.00
AM113	M1809 POTSDAM TOP BAND, Brass (Reproduction) .....	45.00
AM114	POTSDAM TYPE II TOP BAND, Brass, Notched for Barrel Stud (Reproduction) .....	45.00
AM115	TRIGGER GUARD SWIVEL, With Screw (Reproduction) .....	20.00
AM116	MIDDLE BAND SWIVEL, With Screw (Reproduction) .....	20.00
AM117	BAND SPRING, FRONT (Reproduction) .....	19.00
AM118	BAND SPRING, MIDDLE, LOWER (Reproduction) .....	19.00
AM119	POTSDAM BAYONET CATCH (Reproduction) .....	38.00
AM124	POTSDAM MIDDLE BARREL BAND (Reproduction) .....	38.00

## 1813 HALL RIFLE & CARBINE

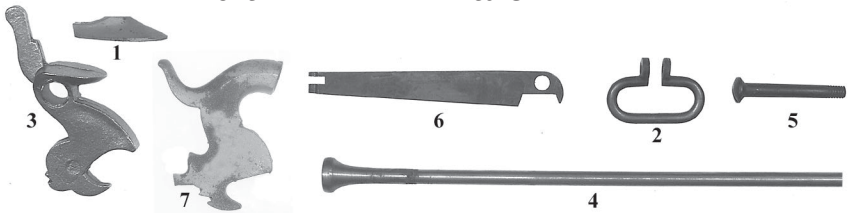

HL1	M1813 HALL CARBINE & RIFLE TOP JAW, Investment Cast Steel (Reproduction) .....	17.00
HL2	M1813 HALL CARBINE & RIFLE SLING SWIVEL (Reproduction) .....	10.00
HL3	HALL RIFLE AND CARBINE HAMMER Investment Cast Steel (Reproduction) .....	42.00
HL4	HALL RIFLE RAMROD (Reproduction), Can be shortened to fit Carbine .....	40.00
HL5	HALL CARBINE SADDLE BAR SCREW (Original) .....	15.00
HL6	HALL MAINSPRING, Fitted and tempered .....	70.00
HL7	1843 HALL PERCUSSION HAMMER (Reproduction) .....	42.00

## 1816 REMINGTON MAYNARD



RM101	TUMBLER .....	60.00
RM102	FEED HAND .....	42.00
RM103	PERCUSSION CONVERSION HAMMER .....	55.00
RM104	LOCKPLATE PRIMER DOOR WITH KNOB AND HINGE POSTS (Repro) .....	40.00
RM105	HINGE POST FOR DOOR, set of 2, Top and Bottom (Repro) .....	15.00
RM106	PRIMER DOOR KNOB (Repro) .....	8.00
RM107	PRIMER DOOR CATCH (Repro) .....	18.00
RM108	MAINSPRING .....	72.00

## 1817 COMMON RIFLE

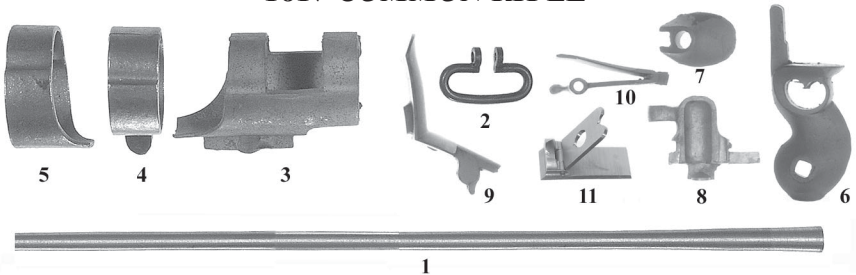

17C1	M1817 COMMON RIFLE RAMROD (Reproduction) .....	45.00
17C2	SLING SWIVEL (Reproduction) .....	10.00
17C3	FRONT BARREL BAND, Investment Cast (Reproduction) .....	38.00
17C4	MIDDLE BARREL BAND, Without Swivel (Reproduction) .....	30.00
17C5	LOWER BARREL BAND, Investment Cast (Reproduction) .....	30.00
17C6	FLINT HAMMER (Reproduction) .....	36.00
17C7	FLINT HAMMER JAW (Reproduction) .....	15.00
17C8	BRASS PAN (Reproduction) .....	25.00
17C9	FRIZZEN (Reproduction) .....	36.00
17C10	FRIZZEN SPRING (Reproduction) .....	22.00
17C11	REAR SIGHT, For Deringer Marked Rifles (Reproduction) .....	85.00

**VISIT US ONLINE AT [WWW.SSFIREARMS.COM](http://WWW.SSFIREARMS.COM)**

Check our Website every December for Christmas Specials.

# 1816 SPRINGFIELD

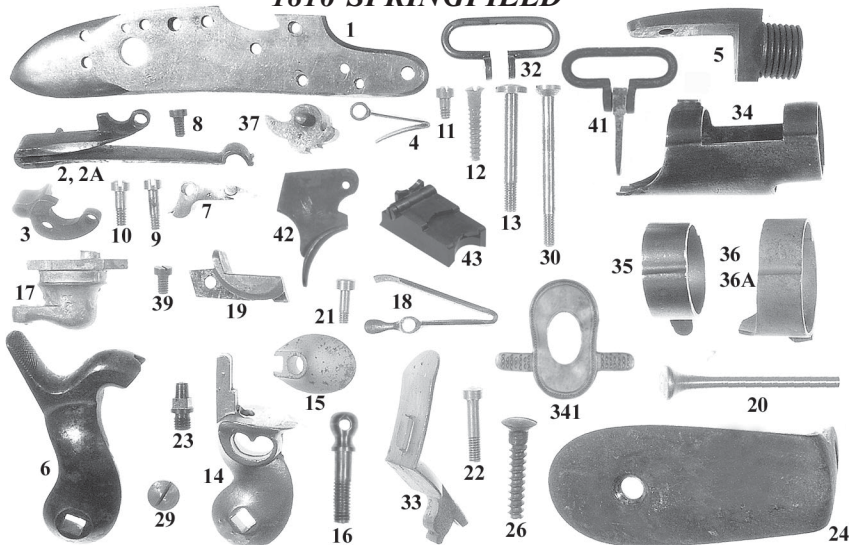

16S1	LOCKPLATE, Stripped, Various Dates and Makers .....	80.00
16S2	MAINSRING .....	75.00
16S2A	MAINSRING (Reproduction) .....	40.00
16S3	BRIDLE .....	25.00
16S4	SEAR SPRING .....	35.00
16S5	BREECH SCREW, Various Dates .....	40.00
16S6	PERCUSSION ALTERATION HAMMER, Original .....	60.00
16S7	SEAR .....	50.00
16S8	MAINSRING SCREW .....	4.00
16S9	SEAR SCREW (Reproduction) .....	4.00
16S10	BRIDLE SCREW (Reproduction) .....	4.00
16S11	SEAR SPRING SCREW (Reproduction) .....	4.00
16S12	GUARD PLATE WOOD SCREW (Trigger Bar) .....	8.00
16S13	SIDE PLATE (LOCKPLATE) SCREW (Reproduction) .....	7.00
16S14	FLINT HAMMER, Investment Cast Steel (Reproduction) .....	36.00
16S15	FLINT HAMMER TOP JAW, Investment Cast Steel (Reproduction) .....	15.00
16S16	FLINT HAMMER JAW SCREW (Reproduction) .....	8.50
16S17	BRASS PAN (Reproduction) .....	25.00
16S18	FLINT FRIZZEN SPRING, Tempered (Reproduction) .....	22.00
16S19	BRASS PAN INSERT (Percussion Alteration), Original .....	15.00
16S20	RAMROD, Machined Steel (Reproduction) .....	40.00
16S21	FRIZZEN SPRING SCREW (Reproduction) .....	4.00
16S22	FRIZZEN SCREW (Reproduction) .....	4.00
16S23	NIPPLE, Percussion Alteration (Reproduction) .....	5.00
16S24	BUTTPLATE, Original .....	60.00
16S26	BUTTPLATE WOOD SCREW .....	17.50
16S29	HAMMER SCREW (Reproduction) .....	7.00
16S30	TANG SCREW (Reproduction) .....	7.00
16S32	BAND SWIVEL, UPPER, LOWER (Reproduction) .....	10.00
16S33	FLINT FRIZZEN, Investment Cast Steel (Reproduction) .....	36.00
16S34	TOP BAND, Investment Cast Steel (Reproduction) .....	38.00
16S35	MIDDLE BAND, Investment Cast Steel, Not drilled for swivel (Reproduction) .....	30.00
16S36	LOWER BAND, Investment Cast Steel (Reproduction) .....	30.00
16S36A	LOWER BAND, original .....	45.00
16S37	TUMBLER .....	75.00
16S39	PAN SCREW .....	4.00
16S41	TRIGGER BOW SWIVEL, With Bow Stud .....	40.00
16S42	TRIGGER .....	35.00
16S43	H&P CIVIL WAR CONVERSION REAR SIGHT, Repro .....	70.00
AP341	M1816 FLINT LOAD CAP, Wraps Around Flint To Securely Hold In Jaw (Reproduction) .....	4.00
AP601	.69 CAL TOMPION, Turned Wood, Repro .....	4.00

# 1841 MISSISSIPPI

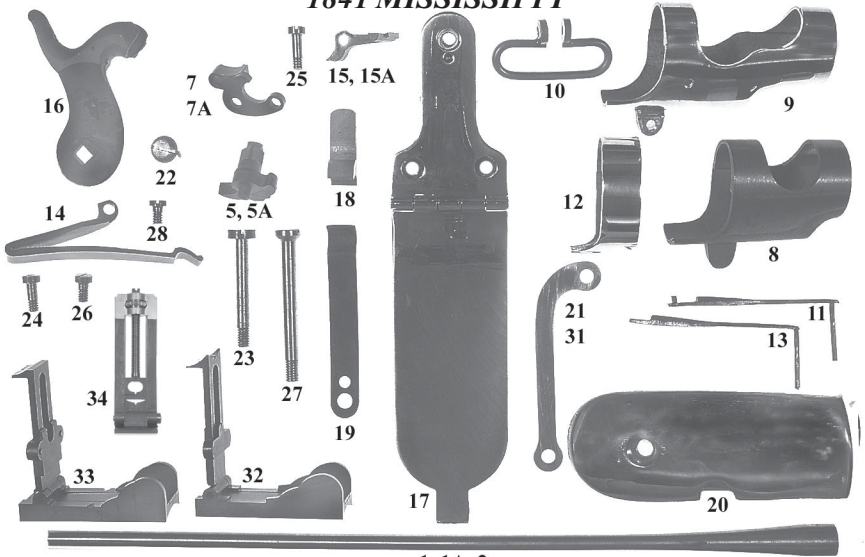

1, 1A, 2

41S101	RAMROD, Brass Tip .....	45.00
41S101A	RAMROD, All Brass For Shooters .....	30.00
41S102	RAMROD, Steel As Arsenal Supplied, For .58 Conversion (New Manufacture) .....	45.00
41S105	TUMBLER, Cast .....	22.00
41S105A	TUMBLER, Machined, Hardened With Screw .....	60.00
41S107	BRIDLE, Cast .....	15.00
41S107A	BRIDLE, Machined .....	30.00
41S108	FRONT BARREL BAND, Short, No Swivel .....	38.00
41S109	FRONT BARREL BAND, Long, No Swivel .....	38.00
41S110	FRONT BAND AND TRIGGERGUARD SWIVEL .....	10.00
41S111	FRONT BAND RETAINING SPRING .....	9.50
41S112	LOWER BAND .....	30.00
41S113	REAR BAND RETAINING SPRING .....	10.00
41S114	MAINSRING, Heat Treated .....	48.00
41S115	SEAR, Cast .....	20.00
41S115A	SEAR, Machined, Hardened .....	35.00
41S116	HAMMER, Cast .....	38.00
41S117	PATCHBOX, Complete With Cam and Spring, Finished .....	75.00
41S118	PATCHBOX LOCKING CAM .....	15.00
41S119	PATCHBOX SPRING .....	8.00
41S120	BUTT PLATE .....	35.00
41S121	SIDE PLATE, Brass .....	12.50
41S122	HAMMER SCREW .....	6.00
41S123	SIDE PLATE SCREW .....	6.00
41S124	SEAR SCREW .....	4.00
41S125	BRIDLE SCREW .....	4.00
41S126	SEAR SPRING SCREW .....	4.00
41S127	TANG SCREW .....	6.00
41S128	MAINSRING SCREW .....	4.00
41S131	SIDEPLATE, Steel .....	12.00
41S132	LONG RANGE REAR SIGHT, With Spring .....	85.00
41S133	LONG RANGE REAR SIGHT, With Spring, Early version Pattern .....	85.00
41S134	BENTON REAR SIGHT .....	110.00

NOTE: All above parts are reproductions for use on original firearms and will require minimum finishing.

## UNCATALOGED ITEMS

Please note we have listed only items that we have in sufficient quantity. We do have many "single" items and parts that are unlisted. All we ask is for a S.A.S.E. and on a separate sheet of paper a brief but specific request. We will respond to your request on items available, or will hold your request until we can supply it. All this is without obligation for you to purchase.

# 1842 SPRINGFIELD

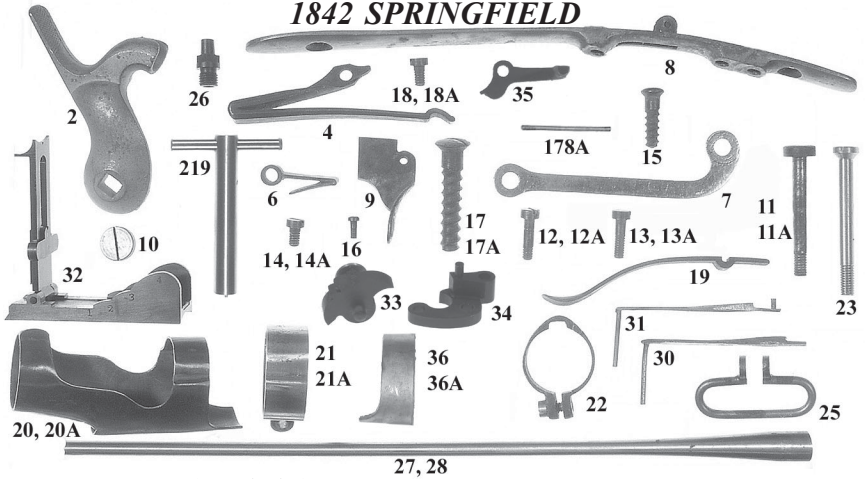

	27, 28	
42S2	HAMMER (Reproduction) .....	38.00
42S4	MAINSRING .....	40.00
42S6	SEAR SPRING .....	35.00
42S7	SIDE PLATE .....	15.00
42S8	GUARD PLATE (Trigger Bar) .....	50.00
42S9	TRIGGER .....	15.00
42S10	HAMMER SCREW (Reproduction) .....	7.00
42S11	SIDE PLATE SCREW .....	15.00
42S11A	SIDE PLATE SCREW (Reproduction) .....	7.00
42S12	SEAR SCREW .....	5.00
42S12A	SEAR SCREW (Reproduction) .....	4.00
42S13	BRIDLE SCREW .....	5.00
42S13A	BRIDLE SCREW (Reproduction) .....	4.00
42S14	SEAR SPRING SCREW .....	5.00
42S14A	SEAR SPRING SCREW (Reproduction) .....	4.00
42S15	GUARD PLATE WOOD SCREW, Front (Trigger Bar) .....	8.50
42S16	TRIGGER SCREW .....	3.00
42S17	BUTT PLATE WOOD SCREW .....	15.00
42S17A	BUTT PLATE WOOD SCREW (Reproduction) .....	10.00
42S18	MAINSRING SCREW .....	4.00
42S18A	MAINSRING SCREW (Reproduction) .....	4.00
42S19	RAMROD SPOON .....	15.00
42S20	TOP BAND (Reproduction) .....	38.00
42S20A	TOP BAND, Brass (Reproduction) .....	50.00
42S21	MIDDLE BAND W/O SWIVEL (Reproduction) .....	30.00
42S21A	MIDDLE BAND W/O SWIVEL, Brass (Reproduction) .....	38.00
42S22	BAYONET LOCKING RING WITH SCREW .....	45.00
42S23	TANG SCREW (Reproduction) .....	7.00
42S25	SLING SWIVEL, Triggerguard Or Band (Reproduction) .....	10.00
42S26	NIPPLE (Reproduction) .....	5.00
42S27	RAMROD (Reproduction) .....	40.00
42S28	RAMROD, CUPPED END, FOR USE WITH RIFLED BARRELS (Reproduction) .....	40.00
42S30	LOWER, MIDDLE BAND SPRING (Reproduction) .....	10.00
42S31	UPPER BAND SPRING WITH LUG (Reproduction) .....	10.00
42S32	1842 LONG RANGE REAR SIGHT, With Spring and Screw (Reproduction) .....	85.00
42S33	TUMBLER, Fully Machined with Hammer Screw (Reproduction) .....	60.00
42S34	BRIDLE, Fully Machined (Reproduction) .....	30.00
42S35	SEAR, Fully Machined (Reproduction) .....	30.00
42S36	LOWER BAND (Reproduction) .....	32.00
42S36A	LOWER BAND, Brass (Reproduction) .....	38.00
58S178A	RAMROD SPRING RETAINING PIN .....	4.00
58S219	REAR SIGHT BASE SCREW WRENCH, Twin Spanner, Fits M1842-M1870 .....	10.00
AP344	1842 COMBINATION TOOL (Reproduction) .....	14.00
AP601	.69 CAL TOMPION, Turned Wood, Repro .....	4.00

See Page 30 For Armi Sport Replica 1842 Parts

## MODEL 1835/40

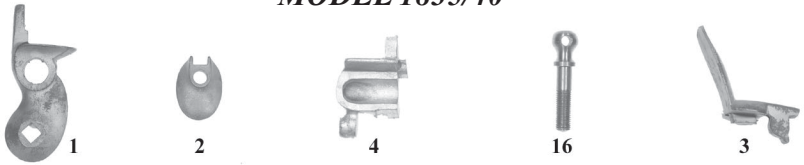

35S1	M35/40 FLINT HAMMER, Investment Cast Steel (Reproduction) .....	36.00
35S2	M35/40 FLINT HAMMER TOP JAW, Investment Cast Steel (Reproduction) .....	15.00
35S3	M35/40 FRIZZEN, Investment Cast Steel (Reproduction) .....	36.00
35S4	M35/40 PAN, Investment Cast Brass (Reproduction) .....	25.00
16S16	M35/40 JAW SCREW, 5/16 x 24 Thread (Reproduction) .....	8.50

## 1847 MUSKETOON



47S1	FRONT BAND, CAVALRY MODEL, Brass, (Reproduction) .....	46.00
47S2	FRONT BAND, ARTILLERY MODEL, Steel, (Reproduction) .....	46.00
47S3	FRONT BAND, MINERS & SAPPERS, With Bayonet Lug, Steel (Reproduction) .....	82.00
47S4	REAR BAND, CAVALRY MODEL, Brass, (Reproduction) .....	46.00
47S5	REAR BAND, ARTILLERY MODEL, Steel, (Reproduction) .....	46.00
47S6	RAMROD ARMS AND SWIVEL (Reproduction) .....	40.00

The Above Parts Are All Castings and Require Finishing

## 1851 CADET

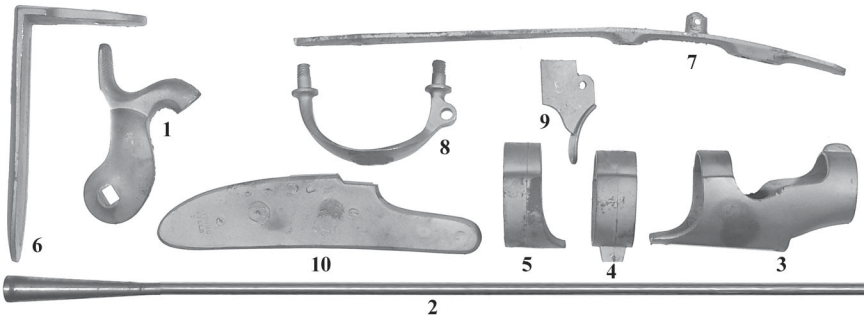

51S1	HAMMER (Reproduction), Investment Cast Steel .....	38.00
51S2	RAMROD (Reproduction) .....	45.00
51S3	TOP BAND, (Reproduction), Investment Cast Steel .....	42.00
51S4	MIDDLE BAND, (Reproduction), Investment Cast Steel .....	32.00
51S5	LOWER BAND, (Reproduction), Investment Cast Steel .....	32.00
51S6	BUTTPLATE, (Reproduction), Investment Cast Steel .....	38.00
51S7	TRIGGER PLATE, (Reproduction), Investment Cast Steel .....	32.00
51S8	TRIGGER BOW, (Reproduction), Investment Cast Steel .....	26.00
51S9	TRIGGER, (Reproduction), Investment Cast Steel .....	12.50
51S10	LOCKPLATE, (Reproduction), Investment Cast Steel .....	45.00

# 1855 SPRINGFIELD

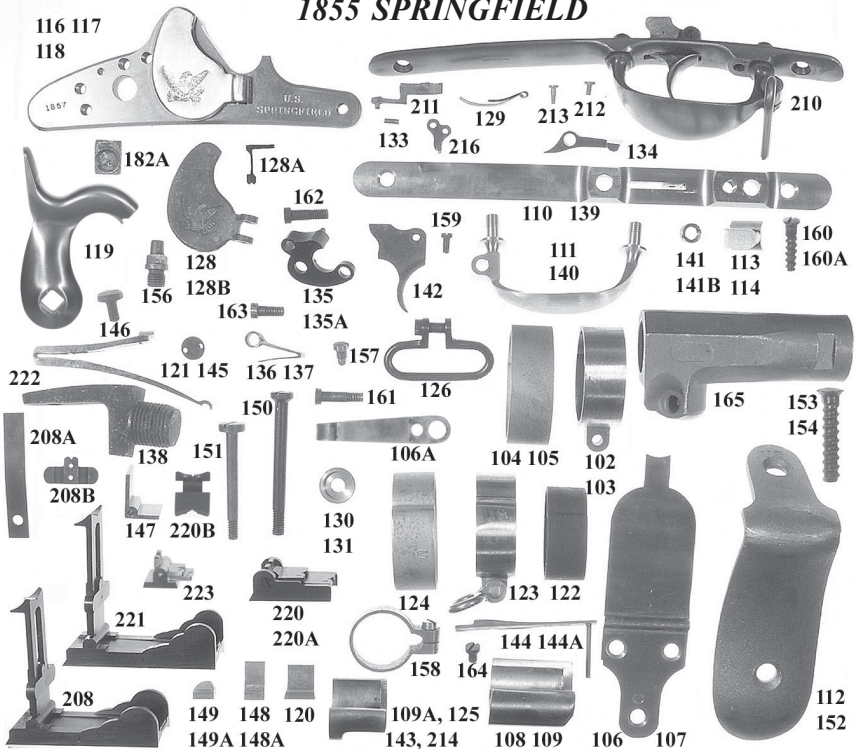

58S102	RIFLE TOP BAND, Without Swivel, Brass (Reproduction) .....	25.00
58S103	RIFLE TOP BAND, Without Swivel, Steel (Reproduction) .....	25.00
58S104	RIFLE LOWER BAND, Brass (Reproduction) .....	25.00
58S105	RIFLE LOWER BAND, Steel (Reproduction) .....	25.00
58S106	PATCH BOX, Complete, Brass (Reproduction) .....	45.00
58S106A	PATCH BOX SPRING (Reproduction) .....	10.00
58S107	PATCH BOX, Complete, Steel (Reproduction) .....	45.00
58S108	RIFLE NOSE CAP, Brass (Reproduction) .....	22.00
58S109	RIFLE NOSE CAP, Steel (Reproduction) .....	22.00
58S109A	1855 RIFLE SHORT STEEL NOSE CAP (Reproduction) .....	25.00
58S110	RIFLE TRIGGER BAR, Brass (Reproduction) .....	65.00
58S111	RIFLE TRIGGER BOW, Without Swivel, Brass (Reproduction) .....	65.00
58S112	RIFLE BUTT PLATE, Brass (Reproduction) .....	40.00
58S113	RIFLE BAYONET LUG, Dovetail Base (Reproduction) .....	16.00
58S114	RIFLE BAYONET LUG, Radius Base, Solder On (Reproduction) .....	16.00
58S116	LOCKPLATE, Stationary Door, Springfield, various dates (Reproduction) .....	95.00
58S117	LOCKPLATE, Stationary Door, Harper's Ferry, various dates (Reproduction) .....	95.00
58S118	LOCKPLATE, Stationary Door, E. Whitney, N. Haven, various dates (Repro) .....	95.00
58S119	HAMMER, Investment Cast Steel, Notch cut for Maynard tape (Reproduction) .....	42.00
58S120	FRONT SIGHT, RIFLE, Competition, New Manufacture .....	15.00
58S120A	FRONT SIGHT, RIFLE, Competition, Dovetail, New Manufacture .....	24.00
58S121	LONG RANGE SIGHT SCREW .....	8.00
58S122	TOP BAND .....	25.00
58S123	MIDDLE BAND, Complete with Swivel (Reproduction) .....	42.00
58S124	LOWER BAND, (Reproduction) .....	25.00
58S125	MUSKET NOSE CAP, 3 Band, Brass (Reproduction) .....	30.00
58S126	SWIVEL, UPPER, LOWER, With Screw (Reproduction) .....	10.00
58S127	RAMROD, 3 Band Musket (Reproduction) .....	45.00
58S127A	RAMROD, 1855 2 Band Rifle .....	45.00
58S128	MAYNARD TAPE PRIMER DOOR, Investment Cast (Reproduction) .....	35.00
58S128A	MAYNARD TAPE PRIMER DOOR CATCH (Reproduction) .....	18.00









## 1855 SPRINGFIELD



















































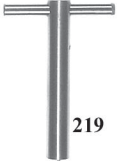
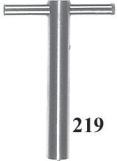





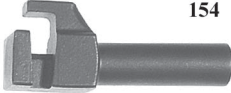









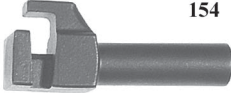



58S128B	MAYNARD TAPE PRIMER DOOR, Fully Machined and Finished with Pivot Pin, Repro ..	65.00
58S129	MAYNARD PRIMER FEED SPRING (Reproduction) .....	18.00
58S130	SIDE SCREW WASHER, Steel (Reproduction) .....	4.00
58S131	SIDE SCREW WASHER, Brass (Reproduction) .....	4.00
58S133	TUMBLER STIRRUP PIVOT PIN .....	3.00
58S134	SEAR .....	35.00
58S135	BRIDLE, Fully Machined, (Reproduction) .....	28.00
58S135A	BRIDLE, Original .....	45.00
58S136	SEAR SPRING .....	40.00
58S137	SEAR SPRING, Replacement Circa 1910 .....	10.00
58S138	BREECH SCREW .....	32.00
58S138A	BREECH SCREW WRENCH .....	30.00
58S139	TRIGGER BAR, Steel .....	45.00
58S140	TRIGGER BOW (Reproduction) .....	40.00
58S141	TRIGGER BOW NUT, Steel .....	6.00
58S141B	TRIGGER BOW NUT (Reproduction) .....	3.50
58S142	TRIGGER (Reproduction) .....	12.00
58S143	NOSE CAP, Steel .....	40.00
58S144	BAND SPRING .....	25.00
58S144A	BAND SPRING (Reproduction) .....	10.00
58S145	REAR SIGHT BASE SCREW .....	5.00
58S146	HAMMER SCREW .....	4.00
58S147	REAR SIGHT LEAF, L SHAPED, For Competition (New Manufacture) .....	14.00
58S148	FRONT SIGHT, Musket, Competition (New Manufacture) .....	15.00
58S148A	FRONT SIGHT, Musket, Competition, Dovetail (New Manufacture) .....	24.00
58S149	FRONT SIGHT, 3 Band, Original Style (Reproduction) .....	15.00
58S150	TANG SCREW (Reproduction) .....	6.00
58S151	SIDE PLATE SCREW (Reproduction) .....	6.00
58S152	BUTT PLATE, Investment Cast Steel (Reproduction) .....	35.00
58S153	BUTT PLATE WOOD SCREW .....	8.50
58S154	BUTT PLATE WOOD SCREW, Finished (Reproduction) .....	6.00
58S156	NIPPLE (Reproduction) .....	5.00
58S157	BOLSTER CLEANOUT SCREW (Reproduction) .....	4.00
58S158	BAYONET LOCKING RING with Screw .....	16.00
58S159	TRIGGER SCREW .....	3.00
58S160	GUARD PLATE WOOD SCREW (Trigger Bar) .....	6.00
58S160A	GUARD PLATE WOOD SCREW (Trigger Bar), Reproduction .....	4.00
58S161	SEAR SCREW .....	3.00
58S162	BRIDLE SCREW .....	3.00
58S163	SEAR SPRING SCREW .....	3.00
58S164	NOSE CAP SCREW (Reproduction) .....	4.00
58S165	CAST STEEL BREECH SECTION, 3 1/4" Long .....	30.00
58S182A	RAMROD RETAINING PLATE .....	3.00
58S208	1855 3 BAND MUSKET LONG RANGE REAR SIGHT (Reproduction) .....	85.00
58S208A	1855 3 BAND MUSKET LONG RANGE REAR SIGHT BASE SPRING (Reproduction) .....	8.00
58S208B	1855 LONG RANGE REAR SIGHT SLIDE, Original .....	20.00
58S210	TRIGGER GUARD ASSEMBLY, Complete, Steel (Reproduction) .....	90.00
58S211	1855 MAYNARD TAPE FEED HAND (Reproduction) .....	18.00
58S212	1855 MAYNARD DOOR CATCH SCREW (Reproduction) .....	4.00
58S213	1855 MAYNARD FEED SPRING SCREW (Reproduction) .....	4.00
58S214	NOSECAP, Steel (Reproduction) .....	15.00
58S215	RAMROD, Steel, 33" Artillery Model (Reproduction) .....	30.00
58S216	1855 TUMBLER STIRRUP (Reproduction) .....	22.00
58S219	REAR SIGHT SCREW WRENCH, Twin Spanner, Fits M1842-M1870 .....	10.00
58S220	1855 REAR SIGHT, Complete (Reproduction) .....	45.00
58S220A	1855 REAR SIGHT, Blued, High Quality, Complete (Reproduction) .....	65.00
58S220B	REAR SIGHT LEAF, Short, 100 & 300yd (Reproduction) .....	20.00
58S221	1855 REAR SIGHT, 2 BAND RIFLE (Reproduction) .....	85.00
58S222	M1855 MAINSPRING (Reproduction) .....	40.00
58S223	1855 CARBINE REAR SIGHT (Reproduction) .....	75.00
AP345	1855 COMBINATION TOOL (Reproduction) .....	14.00
AP602	TOMPION, Brass Head, Beechwood Body (Reproduction) .....	5.00

**LOCKPLATES USE ORIGINAL PARTS & 1861 MAINSPRING, NOT MACHINED FOR MAYNARD TAPE SYSTEM**

## 1855 PISTOL CARBINE

					
<b>101</b>	<b>100</b>	<b>101A</b>	<b>101B</b>	<b>101C</b>	<b>101D</b>
58S100	1855 PISTOL CARBINE DOOR (Reproduction) .....				35.00
58S101	PISTOL CARBINE HAMMER CASTING .....				22.00
58S101A	PISTOL CARBINE TRIGGER .....				45.00
58S101B	PISTOL CARBINE TUMBLER STIRRUP .....				30.00
58S101C	PISTOL CARBINE REAR SIGHT, Complete with mounting screw (Reproduction) .....				85.00
58S101D	BRASS MOUNT, For Shoulder stock to Pistol, unfinished casting .....				35.00

## 1861 SPRINGFIELD

											
<b>166</b>	<b>161</b>	<b>162</b>	<b>163</b>	<b>135</b>	<b>170</b>	<b>133</b>	<b>168</b>	<b>134</b>	<b>136</b>		
				<b>135A</b>			<b>169</b>		<b>137</b>		
											
<b>167</b>	<b>171</b>			<b>210</b>		<b>160</b>		<b>130</b>			
											
<b>146</b>	<b>156</b>	<b>172</b>	<b>210A</b>		<b>160A</b>		<b>141</b>		<b>151</b>		
											
<b>147</b>	<b>138</b>		<b>142</b>		<b>140</b>		<b>141B</b>		<b>150</b>		
											
<b>165</b>		<b>126</b>		<b>140A</b>		<b>159</b>		<b>151</b>		<b>150</b>	
											
<b>124</b>	<b>123</b>	<b>122</b>	<b>143 214</b>		<b>164</b>	<b>158</b>		<b>219</b>		<b>219</b>	
											
<b>603</b>		<b>173</b>		<b>319</b>		<b>153</b>		<b>154</b>		<b>138A</b>	
											
<b>174</b>		<b>145</b>		<b>319A</b>		<b>153</b>		<b>154</b>		<b>152</b>	
											
<b>174B</b>		<b>207</b>		<b>207A</b>		<b>206</b>		<b>138A</b>		<b>152</b>	
											
<b>147</b>		<b>148</b>		<b>149</b>		<b>182A</b>		<b>152</b>		<b>152A</b>	
											
<b>148A</b>		<b>149A</b>		<b>127</b>		<b>127</b>		<b>127</b>		<b>127</b>	
58S122	TOP BAND .....				25.00						
58S123	MIDDLE BAND, Complete with Swivel (Reproduction) .....				45.00						
58S124	LOWER BAND, (Reproduction) .....				25.00						
58S126	SWIVEL, UPPER, LOWER, With Screw (Reproduction) .....				10.00						
58S127	RAMROD, 3 Band Musket (Reproduction) .....				45.00						
58S130	SIDE SCREW WASHER, Steel (Reproduction) .....				4.00						

## 1861 SPRINGFIELD

58S133	TUMBLER STIRRUP PIVOT PIN .....	3.00
58S134	SEAR .....	35.00
58S135	BRIDLE Fully Machined (Reproduction) .....	28.00
58S135A	BRIDLE, Original .....	45.00
58S136	SEAR SPRING .....	40.00
58S137	SEAR SPRING, Replacement Circa 1910 .....	10.00
58S138	BREECH SCREW .....	32.00
58S138A	BREECH SCREW WRENCH .....	30.00
58S139	TRIGGER BAR .....	45.00
58S140	TRIGGER BOW (Reproduction) .....	40.00
58S140A	TRIGGER BOW, Original .....	45.00 - 75.00
58S141	TRIGGER BOW NUT .....	6.00
58S141B	TRIGGER BOW NUT (Reproduction) .....	3.50
58S142	TRIGGER (Reproduction) .....	12.00
58S142A	TRIGGER, Original .....	35.00
58S143	NOSE CAP, Steel .....	40.00
58S144	BAND SPRING .....	25.00
58S144A	BAND SPRING (Reproduction) .....	10.00
58S145	REAR SIGHT BASE SCREW .....	5.00
58S146	HAMMER SCREW .....	5.00
58S147	REAR SIGHT LEAF, L SHAPED, For Competition (New Manufacture) .....	14.00
58S148	FRONT SIGHT, Musket, Competition (New Manufacture) .....	15.00
58S148A	FRONT SIGHT, Musket, Competition, Dovetail (New Manufacture) .....	24.00
58S149	FRONT SIGHT, Complete (Reproduction) .....	15.00
58S149A	FRONT SIGHT, ORIGINAL, Unfinished .....	15.00
58S150	TANG SCREW (Reproduction) .....	6.00
58S151	SIDE PLATE SCREW (Reproduction) .....	6.00
58S152	BUTT PLATE, Investment Cast Steel (Reproduction) .....	35.00
58S152A	BUTT PLATE, Original .....	45.00 - 85.00
58S153	BUTT PLATE WOOD SCREW .....	8.50
58S154	BUTT PLATE WOOD SCREW, Finished (Reproduction) .....	6.00
58S156	NIPPLE (Reproduction) .....	5.00
58S156A	NIPPLE, Small Hole Original Style (Reproduction) .....	6.00
58S157	BOLSTER CLEANOUT SCREW (Reproduction) .....	4.00
58S158	BAYONET LOCKING RING With Screw .....	16.00
58S159	TRIGGER SCREW .....	3.00
58S160	GUARD PLATE WOOD SCREW (Trigger Bar) .....	6.00
58S160A	GUARD PLATE WOOD SCREW (Trigger Bar) Reproduction .....	4.00
58S161	SEAR SCREW .....	3.00
58S162	BRIDLE SCREW .....	3.00
58S163	SEAR SPRING SCREW .....	3.00
58S164	NOSE CAP SCREW (Reproduction) .....	4.00
58S165	CAST STEEL BREECH SECTION, 3 1/4" Long .....	30.00
58S166	LOCKPLATE, U.S. SPRINGFIELD, 1861, 1862, 1863 Dated, Specify (Repro) .....	80.00
58S167	HAMMER, Investment Cast Steel (Reproduction) .....	38.00
58S168	TUMBLER, Complete (Reproduction) .....	35.00
58S169	TUMBLER, Complete .....	70.00
58S170	TUMBLER STIRRUP .....	5.00
58S171	MAINSRING .....	65.00
58S172	MAINSRING (Reproduction) .....	35.00
58S173	REAR SIGHT LEAF SCREW (Reproduction) .....	5.00
58S174	REAR SIGHT, Complete (Reproduction) .....	45.00
58S174B	REAR SIGHT, BLUED, HIGH QUALITY (Reproduction) .....	65.00
58S182A	RAMROD RETAINING PLATE .....	3.50
58S206	REAR SIGHT LEAF, Short, Graduated 100 and 300 Yards (Reproduction) .....	18.00
58S207	REAR SIGHT LEAF, Long, Graduated 500 Yards (Reproduction) .....	14.00
58S207A	HIGH QUALITY MACHINED SET OF SIGHT LEAFS, with cross screw (Reproduction) ..	40.00
58S210	TRIGGER GUARD ASSEMBLY, Complete, Steel (Reproduction) .....	90.00
58S210A	TRIGGER GUARD ASSEMBLY, Complete, Steel, Original .....	95.00 - 125.00
58S214	NOSECAP, Steel (Reproduction) .....	15.00
58S217	REAR SIGHT LEAF, Long, Graduated 500 Yards .....	45.00
58S219	REAR SIGHT BASE SCREW WRENCH, Twin Spanner, Fits M1842-M1870 .....	10.00
AP319	M1863 COMBINATION TOOL. Open End Nipple Wrench, 2 Screwdrivers. (Repro) .....	14.00
AP319A	M1863 COMBINATION TOOL. Open End Nipple Wrench, 2 Screwdrivers. (Original) .....	45.00
AP603	TOMPION, Beechwood (Reproduction) .....	3.00

# 1863-1864 SPRINGFIELD

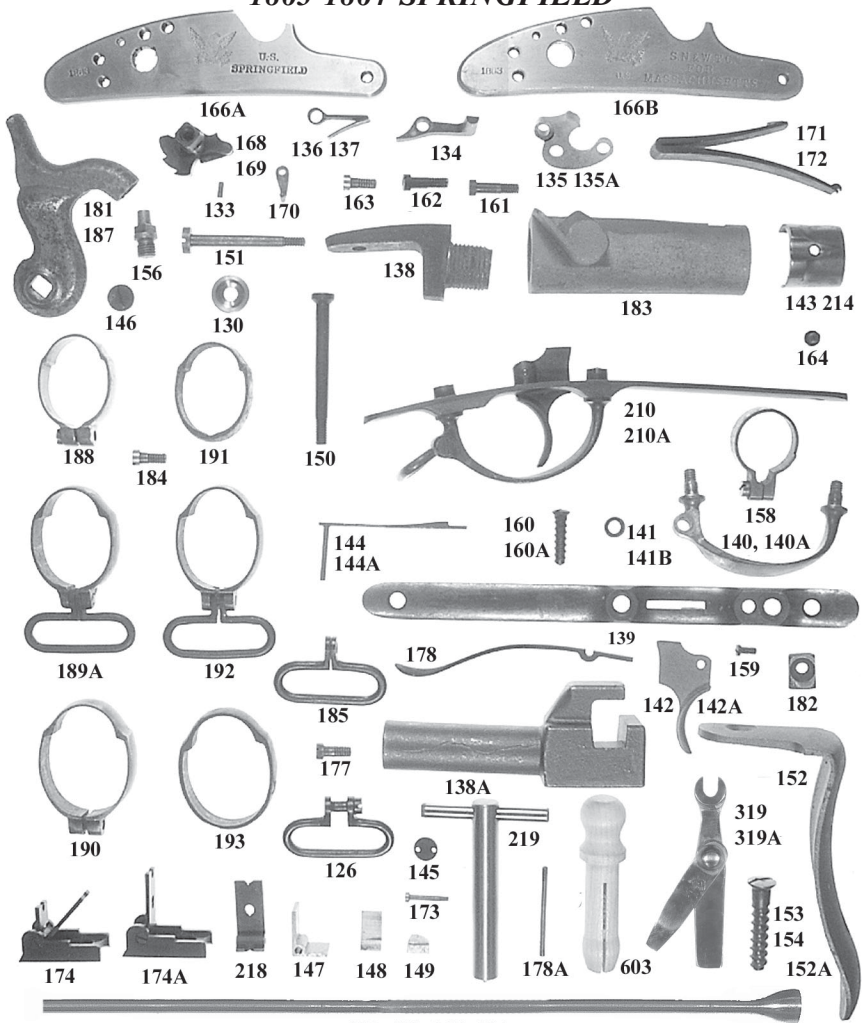

## 179 180 203 204

58S126	LOWER SLING SWIVEL, With Screw (Reproduction) .....	10.00
58S130	SIDE SCREW WASHER, Steel (Reproduction) .....	4.00
58S133	TUMBLER STIRRUP PIVOT PIN .....	3.00
58S134	SEAR .....	35.00
58S135	BRIDLE, Fully Machined, (Reproduction) .....	28.00
58S135A	BRIDLE, Original .....	45.00
58S136	SEAR SPRING .....	40.00
58S137	SEAR SPRING, Replacement Circa 1910 .....	10.00
58S138	BREECH SCREW .....	32.00
58S138A	BREECH PLUG WRENCH .....	30.00
58S139	TRIGGER BAR .....	45.00
58S140	TRIGGER BOW (Reproduction) .....	40.00
58S140A	TRIGGER BOW (Original) .....	45.00 - 75.00
58S141	TRIGGER BOW NUT .....	6.00
58S141B	TRIGGER BOW NUT (Reproduction) .....	3.50
58S142	TRIGGER (Reproduction) .....	12.00
58S142A	TRIGGER, Original .....	35.00

## 1863-1864 SPRINGFIELD

58S143	NOSE CAP, Steel .....	40.00
58S144	BAND SPRING .....	25.00
58S144A	BAND SPRING (Reproduction) .....	10.00
58S145	REAR SIGHT BASE SCREW .....	5.00
58S146	HAMMER SCREW .....	5.00
58S147	REAR SIGHT LEAF, L SHAPED, For Competition (New Manufacture) .....	14.00
58S148	FRONT SIGHT, Musket, Competition (New Manufacture) .....	15.00
58S148A	FRONT SIGHT, Musket, Competition, Dovetail (New Manufacture) .....	24.00
58S149	FRONT SIGHT, Complete (Reproduction) .....	15.00
58S150	TANG SCREW (Reproduction) .....	6.00
58S151	SIDE PLATE SCREW (Reproduction) .....	6.00
58S152	BUTT PLATE, Investment Cast Steel (Reproduction) .....	35.00
58S152A	BUTT PLATE (Original) .....	45.00 - 85.00
58S153	BUTT PLATE WOOD SCREW .....	8.50
58S154	BUTT PLATE WOOD SCREW, Finished (Reproduction) .....	6.00
58S156	NIPPLE (Reproduction) .....	5.00
58S158	BAYONET LOCKING RING With Screw .....	16.00
58S159	TRIGGER SCREW .....	3.00
58S160	GUARD PLATE WOOD SCREW (Trigger Bar) .....	6.00
58S160A	GUARD PLATE WOOD SCREW (Trigger Bar) Reproduction .....	4.00
58S161	SEAR SCREW .....	3.00
58S162	BRIDLE SCREW .....	3.00
58S163	SEAR SPRING SCREW .....	3.00
58S164	NOSE CAP SCREW (Reproduction) .....	4.00
58S166A	LOCKPLATE, U.S. SPRINGFIELD, 1863 Dated, Accepts Original Parts (Reproduction) ...	80.00
58S166B	LOCKPLATE, S.N.& W.T.C. For Massachusetts, Accepts Original Parts (Reproduction) .....	80.00
58S166C	LOCKPLATE, ORIGINAL, Please inquire .....	*
58S168	TUMBLER, Complete (Reproduction) .....	35.00
58S169	TUMBLER, Complete .....	70.00
58S170	TUMBLER STIRRUP .....	5.00
58S171	MAINSRING .....	65.00
58S172	MAINSRING (Reproduction) .....	35.00
58S173	REAR SIGHT LEAF SCREW (Reproduction) .....	5.00
58S174	REAR SIGHT, COMPLETE, M1863 (Reproduction) .....	45.00
58S174A	REAR SIGHT, COMPLETE, M1864 (Reproduction) .....	45.00
58S177	SLING SWIVEL SCREW .....	3.00
58S178	RAMROD SPRING (Spoon) .....	15.00
58S178A	RAMROD SPRING RETAINING PIN .....	4.00
58S179	RAMROD, Artillery Length 33", 2 Band (Modern Manufacture) .....	30.00
58S180	RAMROD, 3 Band (Reproduction) .....	30.00
58S181	HAMMER, Slight Pitting .....	30.00
58S182	RAMROD RETAINING PLATE .....	3.00
58S183	CAST STEEL BREECH SECTION, 3 1/4" Long .....	30.00
58S184	BAND SCREW .....	3.00
58S185	UPPER SLING SWIVEL (Reproduction) .....	10.00
58S187	HAMMER .....	45.00
58S188	M1863 TOP BAND, Screw Type .....	20.00
58S189A	M1863-1864 MIDDLE BAND, Complete With Swivel (Reproduction) .....	40.00
58S190	M1863 LOWER BAND, Screw Type .....	40.00
58S191	M1864 TOP BAND, Solid .....	20.00
58S192	M1863-1864 MIDDLE BAND, Complete With Swivel (Original) .....	80.00
58S193	M1864 LOWER BAND, Solid .....	40.00
58S203	CIVIL WAR MUSKET RAMROD, Brass, 40" (Modern Manufacture) .....	22.00
58S204	CIVIL WAR MUSKET RAMROD, Brass, 33" (Modern Manufacture) .....	22.00
58S210	TRIGGER GUARD ASSEMBLY, Complete, Steel (Reproduction) .....	90.00
58S210A	TRIGGER GUARD ASSEMBLY, Complete, Steel (Original) .....	95.00 - 125.00
58S214	NOSECAP, Steel (Reproduction) .....	15.00
58S218	M1864 REAR SIGHT LEAF (Reproduction) .....	18.00
58S219	REAR SIGHT SCREW WRENCH, Twin Spanner, Fits M1842-M1870 .....	10.00
AP319	M1863 COMBINATION TOOL, Open End Nipple Wrench, 2 Screwdrivers (Reproduction) .....	14.00
AP319A	M1863 COMBINATION TOOL, Open End Nipple Wrench, 2 Screwdrivers (Original) .....	45.00
AP603	TOMPION, Beechwood (Reproduction) .....	3.00
BKA024	1863 SPRINGFIELD MANUAL, Reprint, Please consult book section for additional information.	

# 1861 SPECIAL

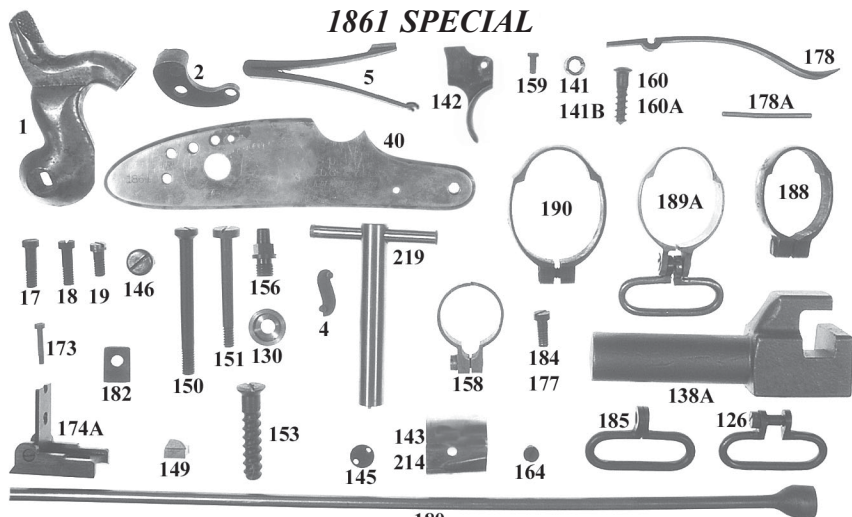

	<b>180</b>	
58S126	LOWER SLING SWIVEL, With Screw (Reproduction) .....	10.00
58S130	SIDE SCREW WASHER (Reproduction) .....	4.00
58S138A	BREECH PLUG WRENCH .....	30.00
58S141	TRIGGER BOW NUT .....	6.00
58S141B	TRIGGER BOW NUT .....	3.50
58S142	TRIGGER (Reproduction) .....	12.00
58S143	NOSE CAP .....	40.00
58S145	REAR SIGHT BASE SCREW .....	5.00
58S146	HAMMER SCREW .....	5.00
58S149	FRONT SIGHT, Complete (Reproduction) .....	15.00
58S150	TANG SCREW (Reproduction) .....	6.00
58S151	SIDE PLATE SCREW (Reproduction) .....	6.00
58S153	BUTT PLATE WOOD SCREW (Reproduction), Finished .....	6.00
58S156	NIPPLE (Reproduction) .....	5.00
58S158	BAYONET LOCKING RING WITH SCREW .....	16.00
58S159	TRIGGER SCREW .....	3.00
58S160	GUARD PLATE WOOD SCREW (Trigger bar) .....	6.00
58S160A	GUARD PLATE WOOD SCREW (Trigger Bar) Reproduction .....	4.00
58S164	NOSE CAP SCREW (Reproduction) .....	4.00
58S173	REAR SIGHT LEAF SCREW (Reproduction) .....	5.00
58S174A	REAR SIGHT, Complete (Reproduction) .....	45.00
58S177	SLING SWIVEL SCREW .....	3.00
58S178	RAMROD SPRING (Spoon) .....	15.00
58S178A	RAMROD SPRING RETAINING PIN .....	4.00
58S180	RAMROD (Reproduction) .....	30.00
58S182	RAMROD STOP PLATE .....	3.00
58S184	BAND SCREW .....	3.00
58S185	UPPER SLING SWIVEL (Reproduction) .....	10.00
58S188	TOP BAND .....	20.00
58S189A	MIDDLE BAND Complete With Swivel (Reproduction) .....	40.00
58S190	LOWER BAND .....	40.00
58S214	NOSE CAP (Reproduction) .....	15.00
58S219	REAR SIGHT BASE SCREW WRENCH, Twin Spanner, Fits M1842-M1870 .....	10.00
61S1	HAMMER .....	40.00
61S2	BRIDLE .....	20.00
61S4	TUMBLER STIRRUP .....	6.00
61S5	MAINSRING .....	60.00
61S17	BRIDLE SCREW .....	3.00
61S18	SEAR SCREW .....	3.00
61S19	SEAR SPRING SCREW .....	3.00
61S40	LOCKPLATE, Marked U.S. L. G. & Y. ....	80.00

## CONFEDERATE MUSKET & CARBINE

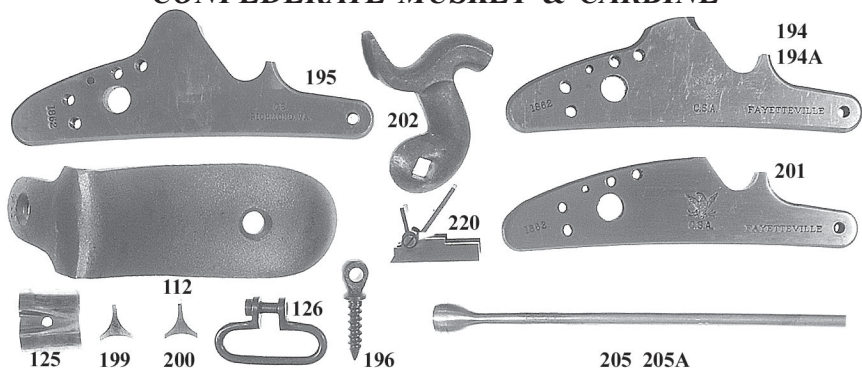

58S112	RICHMOND BUTTPLATE, Brass (Reproduction) .....	40.00
58S125	C.S. RICHMOND MUSKET NOSE CAP, Brass (Reproduction) .....	30.00
58S164	NOSECAP SCREW (Reproduction) .....	5.00
58S194	M1863 RICHMOND LOW HUMP LOCKPLATE, C.S.Rich, Var. Dates (Reproduction) .....	85.00
58S194A	LOW HUMP RICHMOND STYLE LOCKPLATE, Marked Fayetteville .....	85.00
58S195	M1863 RICHMOND HI HUMP LOCKPLATE, C.S.Richmond, Var.Dates (Reproduction) .....	85.00
58S196	C.S. RICHMOND SWIVEL STUD, Finished (Reproduction) .....	18.00
58S126	C.S. RICHMOND SLING SWIVEL, For Above Studs (Reproduction) .....	10.00
58S199	C.S. RICHMOND RIFLE FRONT SIGHT (Reproduction) .....	16.00
58S200	C.S. RICHMOND CARBINE FRONT SIGHT (Reproduction) .....	16.00
58S201	FAYETTEVILLE LOCK PLATE, Various Dates (Reproduction) .....	80.00
58S202	FAYETTEVILLE HAMMER, S SHAPED (Reproduction) .....	40.00
58S205	CIVIL WAR CARBINE RAMROD, Richmond, Brass, 25" (Modern Manufacture) .....	22.00
58S205A	CIVIL WAR CARBINE RAMROD, Richmond, Steel, 25" (Modern Manufacture) .....	30.00
58S220	REAR SIGHT, Complete (Reproduction) .....	45.00

LOCKPLATES USE ORIGINAL PARTS, SCREWS AND M1861 MAINSPRINGS

## WHITNEYVILLE PLYMOUTH

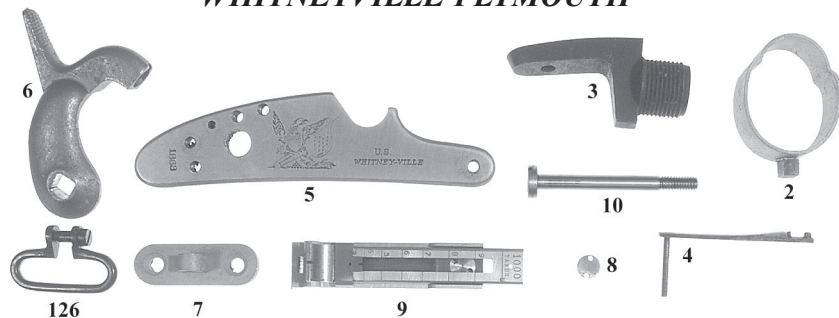

WP2	LOWER BAND, Rifle (Reproduction) .....	30.00
WP3	BREECH SCREW .....	40.00
WP4	TOP BAND SPRING .....	28.00
WP5	LOCKPLATE, Dated 1863 (Reproduction) .....	80.00
WP6	HAMMER (Reproduction) .....	38.00
WP7	BUTTSTOCK SWIVEL BASE (Reproduction) .....	22.00
WP8	REAR SIGHT MOUNTING SCREW, Original .....	8.00
WP9	REAR SIGHT, With Screw (Reproduction) .....	85.00
WP10	LOCKPLATE SCREW (Reproduction) .....	9.00
58S126	SWIVEL, With Screw (Reproduction) .....	10.00

Internal lockplate parts same as 1861 Springfield

**VISIT US ONLINE AT [WWW.SSFIREARMS.COM](http://WWW.SSFIREARMS.COM)**

Check our Website every December for Christmas Specials.

# BRITISH ENFIELD

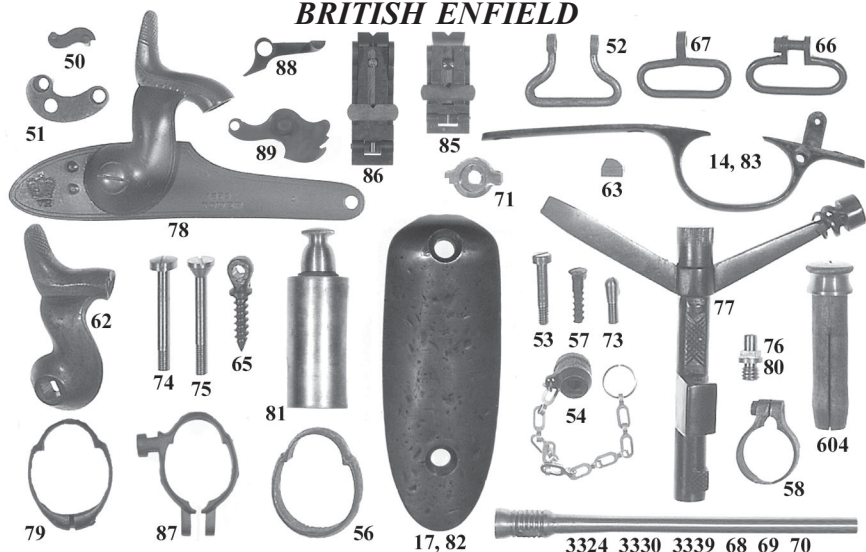

EN50	TUMBLER STIRRUP .....	6.00
EN51	BRIDLE .....	20.00
EN52	GUARD BOW SLING SWIVEL .....	15.00
EN53	GUARD BOW SLING SWIVEL SCREW (Reproduction) .....	5.00
EN54	CONE PROTECTOR, Original Base, New Leather, Chain, And Ring .....	25.00
EN54A	AS ABOVE WITHOUT CHAIN, RING OR LEATHER .....	8.00
EN56	M1853 MIDDLE BAND .....	20.00
EN57	TRIGGER GUARD WOOD SCREW .....	5.00
EN58	BAYONET LOCKING RING WITH SCREW (Blued) .....	35.00
EN62	SNYDER ENFIELD CONVERSION HAMMER .....	30.00
EN63	ENFIELD FRONT SIGHT (Reproduction) .....	15.00
EN65	SERGEANT MODEL BUTTSTOCK SWIVEL STUD, Finished (Reproduction) .....	18.00
EN66	SERGEANT MODEL SWIVEL FOR STUD (Reproduction) .....	10.00
EN67	TOP BAND SWIVEL (Reproduction) .....	10.00
EN68	BRASS RAMROD, 40" (Reproduction) .....	22.00
EN69	BRASS RAMROD, 33" (Reproduction) .....	22.00
EN70	BRASS RAMROD, 26" (Reproduction) .....	22.00
EN71	STOCK WASHER, Square Ear, Brass (Reproduction) .....	4.00
EN73	BANDSCREW, Tapered body, Fits Early Parker-Hale Repro Muskets .....	5.00
EN74	SIDEPLATE SCREW, Fits Early Parker-Hale Repro Muskets .....	6.00
EN75	TANG SCREW, Fits Early Parker-Hale Repro Muskets .....	6.00
EN76	NIPPLE, Fits Early Parker-Hale Repro Muskets .....	6.00
EN77	SERGEANTS MODEL COMBINATION TOOL (Reproduction) .....	48.00
EN78	COMPLETE LOCK ASSY, Marked 1859 TOWER, Crown & V.R. (Reproduction) .....	80.00
EN79	3 BAND SNYDER LOWER BAND .....	25.00
EN80	NIPPLE, STAINLESS STEEL (Replacement) .....	7.00
EN81	REGULATION OIL BOTTLE FOR ENFIELD MUSKETS, Steel Body With Brass Top. Has Oil Dipper Attached To Screw Off Top. Copied From Original .....	25.00
EN82	BUTTPLATE, Brass .....	75.00
EN83	TRIGGERGUARD, Brass .....	80.00
EN85	MUSKETOON REAR SIGHT, Fully Machined and Finished with screw .....	85.00
EN86	3 BAND MUSKET REAR SIGHT, Complete, High Quality Reproduction .....	85.00
EN87	FRONT BAND, Engineers Carbine or 2 Band Short Rifle, w/ Bayonet Lug (Reproduction) ..	60.00
EN88	SEAR, Original .....	45.00
EN89	TUMBLER, Original .....	70.00
EEM14	TRIGGER GUARD, Brass (Reproduction) .....	45.00
EEM17	BUTTPLATE, Brass (Reproduction) .....	45.00
EEM3324	RAMROD, Musketoone (Reproduction) .....	42.00
EEM3330	RAMROD, 2 Band Rifle (Reproduction) .....	42.00
EEM3930	RAMROD, 3 Band (Reproduction) .....	42.00
AP604	ENFIELD TOMPION, Brass Head (Reproduction) .....	5.00



# 1865 SPRINGFIELD

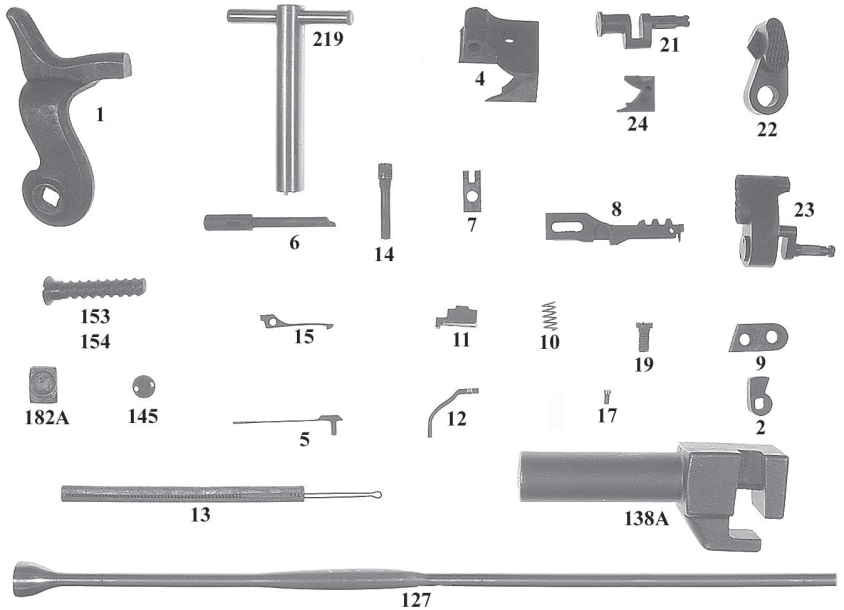

65S1	HAMMER .....	50.00
65S2	CAM .....	6.00
65S4	BREECH BLOCK SUPPORT .....	25.00
65S5	EJECTOR .....	12.00
65S6	FIRING PIN .....	18.00
65S7	EXTRACTOR ARM BASE .....	4.00
65S8	EXTRACTOR RATCHET .....	20.00
65S9	CAM LATCH SIDE PLATE .....	5.00
65S10	FIRING PIN SPRING .....	5.00
65S11	EXTRACTOR .....	20.00
65S12	EXTRACTOR ARM LINKAGE .....	10.00
65S13	EXTRACTOR SPRING AND TUBE ASSEMBLY .....	22.00
65S14	HINGE PIN .....	8.00
65S15	EXTRACTOR RATCHET STOP SPRING .....	20.00
65S17	EXTRACTOR SCREW .....	3.00
65S19	CAM LATCH SCREW .....	3.00
65S21	CAM LATCH SPINDLE (Reproduction) Finished with both screws .....	85.00
65S22	CAM LATCH THUMB PIECE (Reproduction) Finished .....	80.00
65S23	CAM LATCH ASSEMBLY, Finished, Complete, Ready To Install (Reproduction) .....	165.00
65S24	BREECH BLOCK SUPPORT SIDE PLATE .....	10.00
58S127	RAMROD (Reproduction) .....	45.00
58S138A	BREECH SCREW WRENCH .....	30.00
58S145	CAM LATCH THUMB PIECE RETAINING SCREW .....	5.00
58S153	BUTT PLATE WOOD SCREW .....	8.50
58S154	BUTT PLATE WOOD SCREW, Finished (Reproduction) .....	6.00
58S182A	RAMROD STOP PLATE .....	3.00
58S219	REAR SIGHT MOUNTING SCREW WRENCH, Twin Spanner, Fits M1842-M1870 .....	10.00

LOCK PARTS, SCREWS AND FURNITURE SAME AS 1861 SPRINGFIELD

## UNCATALOGED ITEMS

Please note we have listed only items that we have in sufficient quantity. We do have many "single" items and parts that are unlisted. All we ask is for a S.A.S.E. and on a separate sheet of paper a brief but specific request. We will respond to your request on items available, or will hold your request until we can supply it. All this is without obligation for you to purchase.

# 1866 SPRINGFIELD

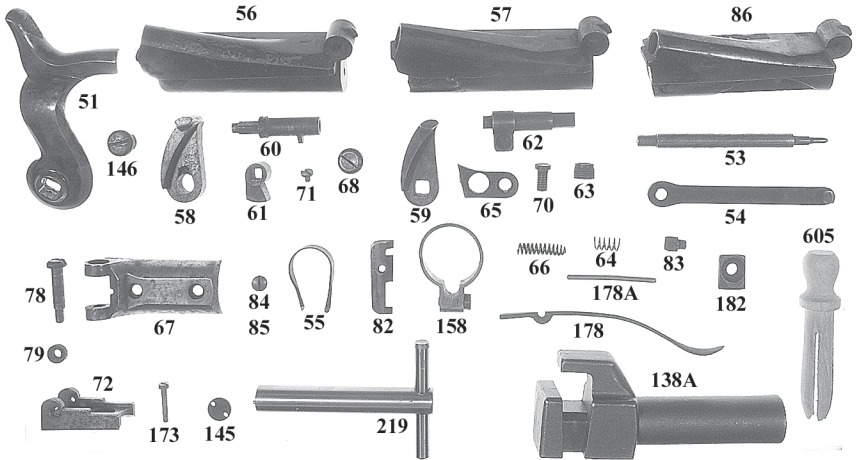

58S138A	BREECH PLUG WRENCH .....	30.00
58S145	REAR SIGHT BASE SCREW .....	5.00
58S146	HAMMER SCREW .....	5.00
58S158	BAYONET LOCKING RING WITH SCREW .....	16.00
58S173	REAR SIGHT LEAF PIVOT SCREW .....	5.00
58S178	RAMROD SPRING (Spoon) .....	15.00
58S178A	RAMROD SPRING RETAINING PIN .....	4.00
58S182	RAMROD RETAINING PLATE .....	3.00
58S219	REAR SIGHT MOUNTING SCREW WRENCH, Twin Spanner, Fits M1842-M1870 .....	10.00
66S51	HAMMER .....	50.00
66S53	FIRING PIN .....	18.00
66S54	EJECTOR FRICTION SPRING .....	9.00
66S55	EXTRACTOR .....	18.00
66S56	BREECH BLOCK, Solid For Round Shank Cam .....	80.00
66S57	BREECH BLOCK, For Square Shank Cam (Has Side Plate) .....	80.00
66S58	CAM LATCH THUMB PIECE, For Round Cam .....	25.00
66S59	CAM LATCH THUMB PIECE, For Square Shank Cam .....	25.00
66S60	CAM LATCH SPINDLE, Round .....	12.00
66S61	CAM FOR ROUND SPINDLE .....	12.00
66S62	CAM LATCH SPINDLE AND LATCH, Square Shank .....	16.00
66S63	FIRING PIN RETAINING BUSHING .....	5.00
66S64	FIRING PIN SPRING .....	5.00
66S65	CAM LATCH SIDE PLATE, For Square Shank .....	5.00
66S66	CAM LATCH SPRING .....	6.00
66S67	HINGE STRAP .....	20.00
66S68	THUMB PIECE SCREW (Reproduction) .....	4.00
66S70	CAM LATCH SIDE PLATE SCREW, For Square Shank .....	3.00
66S71	CAM LATCH SPINDLE SCREW, Round Spindle .....	3.00
66S72	REAR SIGHT BASE .....	40.00
66S78	HINGE SCREW (Breech Block Pivot Screw) .....	17.50
66S79	HINGE SCREW NUT .....	7.50
66S82	EXTRACTOR SIDEPLATE .....	25.00
66S83	EJECTOR STUD .....	3.50
66S84	TOP STRAP SCREW .....	7.50
66S85	TOP STRAP SCREW (Reproduction) .....	4.00
66S86	BREECH BLOCK, CADET MODEL With Lightning Cuts .....	150.00
66S87	RAMROD (Reproduction) .....	45.00
AP605	TOMPION, TURNED BASSWOOD (Reproduction) .....	3.00
BKA025	1866 SPRINGFIELD MANUAL, See Book Section For Complete Description	

LOCK PARTS, SCREWS AND FURNITURE SAME AS 1864 SPRINGFIELD

## 1868-70 SPRINGFIELD

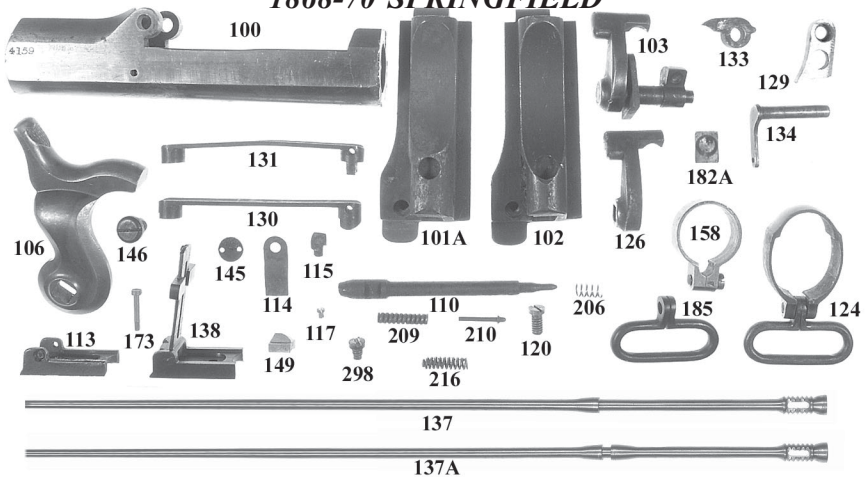

	<b>137</b>	
	<b>137A</b>	
58S138A	BREECHPLUG WRENCH .....	30.00
58S145	REAR SIGHT BASE SCREW .....	5.00
58S146	HAMMER SCREW .....	5.00
58S149	FRONT SIGHT (Reproduction) .....	15.00
58S158	BAYONET LOCKING RING WITH SCREW .....	16.00
58S173	REAR SIGHT LEAF PIVOT SCREW (Reproduction) .....	3.00
58S182A	RAMROD STOP PLATE .....	3.50
58S185	TOP BAND SWIVEL (Reproduction) .....	10.00
58S219	REAR SIGHT MOUNTING SCREW WRENCH, Twin Spanner, Fits M1842-M1870 .....	10.00
68S100	M1868 RECEIVER .....	30.00
68S101A	M1868 BREECH BLOCK, Dated 1870 .....	80.00
68S102	M1870 BREECH BLOCK, Undated .....	80.00
68S103	M1868 CAM LATCH, COMPLETE .....	37.50
68S106	HAMMER .....	50.00
68S110	FIRING PIN .....	25.00
68S113	REAR SIGHT BASE .....	20.00
68S114	REAR SIGHT SPRING .....	7.00
68S115	EJECTOR STUD .....	3.50
68S117	REAR SIGHT ELEVATION BAR RETAINING SCREW .....	4.00
68S120	CAM LATCH SCREW .....	4.00
68S123	TOMPION, Turned Basswood (Reproduction) .....	3.00
68S124	TOP BAND, Complete With Reproduction Sling Swivel .....	48.00
68S126	CAM LATCH THUMB PIECE, M1868 .....	5.00
68S129	CAM LATCH SIDEPLATE .....	5.00
68S130	M1868 RAMROD CATCH .....	12.00
68S131	M1870 RAMROD CATCH .....	12.00
68S133	EXTRACTOR .....	50.00
68S134	HINGE PIN .....	25.00
68S137	M1868 RAMROD, Single Shoulder (Reproduction) .....	45.00
68S137A	M1870 RAMROD, Double Shoulder (Reproduction) .....	45.00
68S138	1868-1870 REAR SIGHT With Spring (Reproduction) .....	55.00
73S206	FIRING PIN SPRING .....	5.00
73S209	EXTRACTOR SPRING .....	6.00
73S210	EXTRACTOR PLUNGER .....	7.00
73S216	CAM LATCH SPRING .....	6.00
73S298	FIRING PIN RETAINING SCREW .....	5.00
AP605	TOMPION, TURNED BASSWOOD (Reproduction) .....	3.00
BKA027	1868 SPRINGFIELD MANUAL, See Book Section For Complete Description	

LOCK PARTS, SCREWS AND FURNITURE SAME AS 1864 SPRINGFIELD

**VISIT US ONLINE AT [WWW.SSFIREARMS.COM](http://WWW.SSFIREARMS.COM)**

Check our Website for Specials, New & Uncataloged Items.

# 1873-1889 SPRINGFIELD



## 1873-1889 SPRINGFIELD

58S133	TUMBLER STIRRUP PIVOT PIN .....	3.00
58S135	BRIDLE, Machined Steel (Reproduction) .....	28.00
58S135A	BRIDLE, Original .....	45.00
58S136	SEAR SPRING .....	40.00
58S137	SEAR SPRING, Replacement (Circa 1910) .....	10.00
58S138A	BREECHPLUG WRENCH .....	30.00
58S140	M1873-1884 TRIGGER BOW (Reproduction) .....	40.00
58S140A	M1873-1884 TRIGGER BOW (Original) .....	45.00 - 75.00
58S141	M1855-1884 TRIGGER BOW NUT .....	6.00
58S141B	M1855-1884 TRIGGER BOW NUT (Reproduction) .....	3.50
58S142	M1873 TRIGGER (Reproduction) .....	12.00
58S144	BAND SPRING .....	25.00
58S144A	BAND SPRING (Reproduction) .....	10.00
58S153	BUTT PLATE WOOD SCREW .....	8.50
58S154	BUTT PLATE WOOD SCREW, Finished (Reproduction) .....	6.00
58S160	GUARD PLATE WOOD SCREW (Trigger Bar) .....	6.00
58S160A	GUARD PLATE WOOD SCREW (Trigger Bar) Reproduction .....	4.00
58S164	M1873-1884 NOSE CAP SCREW (Reproduction) .....	5.00
58S170	TUMBLER STIRRUP .....	5.00
58S171	MAINSRING .....	65.00
58S172	MAINSRING (Reproduction) .....	35.00
73S200	M1873 BREECH BLOCK .....	75.00
73S201	M1878-1884 BREECH BLOCK .....	75.00
73S202	M1873 FIRING PIN .....	25.00
73S203	M1878 FIRING PIN .....	32.00
73S204	M1881 FIRING PIN .....	25.00
73S205	M1884 FIRING PIN, Bronze .....	40.00
73S206	M1873 FIRING PIN SPRING .....	5.00
73S207	EXTRACTOR .....	50.00
73S208	EXTRACTOR, Lug Milled Off For Fencing Model .....	12.00
73S209	EXTRACTOR SPRING .....	6.00
73S210	EXTRACTOR SPRING PLUNGER .....	7.00
73S210A	EXTRACTOR SPRING PLUNGER, Repro .....	5.00
73S211	CAM LATCH, Complete, M1877 thru 1884 .....	35.00
73S212	M1873 THUMBPIECE, Early Pattern .....	10.00
73S213	CAM LATCH THUMB PIECE, M1878 thru 1889 .....	6.00
73S214	BREECH SCREW .....	40.00
73S215	1873 FRONT SIGHT (Reproduction) .....	15.00
73S216	CAM LATCH SPRING .....	6.00
73S217	HINGE PIN .....	25.00
73S218	M1878-1889 FRONT SIGHT BLADE, RIFLE (Reproduction) .....	14.00
73S218A	M1878-1889 FRONT SIGHT BLADE, RIFLE (Original) .....	28.00
73S218B	M1878-1889 FRONT SIGHT BASE, RIFLE (Original) .....	25.00
73S218C	FRONT SIGHT BLADE (Original), UNFINISHED, Requires mounting hole to be drilled .....	3.00
73S218D	1873 FRONT SIGHT BASE, Slotted & Drilled for Blade (Reproduction) .....	20.00
73S221	M1889 TRIGGER, Serrated .....	15.00
73S223	M1873-1884 TRIGGER BAR .....	45.00
73S226	M1873-1889 LOWER SWING SWIVEL, With Screw (Reproduction) .....	10.00
73S228	M1878 TUMBLER, 3 NOTCH, Complete .....	50.00
73S231	M1873 SEAR FOR 2 NOTCH TUMBLER .....	35.00
73S232	M1878 SEAR FOR 3 NOTCH TUMBLER .....	35.00
73S235	EJECTOR STUD .....	3.50
73S236	M1873-1884 NOSE CAP .....	25.00
73S237	SIDE PLATE WASHER .....	6.00
73S238	M1873 BUTT PLATE, RIFLE (Reproduction) .....	35.00
73S238A	M1873 BUTT PLATE, RIFLE (Original) .....	45.00 - 95.00
73S239	M1884 BUTT PLATE TRAP LOCKING SPRING, Flat .....	15.00
73S240	M1884 BUTT PLATE TRAP SPRING .....	15.00
73S245	M1873-1884 RAMROD CATCH .....	12.00
73S246	M1888 RAMROD CATCH COIL SPRING .....	5.00
73S247	M1873 REAR SIGHT, RIFLE, Complete .....	75.00
73S248	M1877 REAR SIGHT, RIFLE, Complete, Notched Steps .....	75.00
73S249	M1877 REAR SIGHT, RIFLE, Complete, No Steps .....	75.00

# 1873-1889 SPRINGFIELD

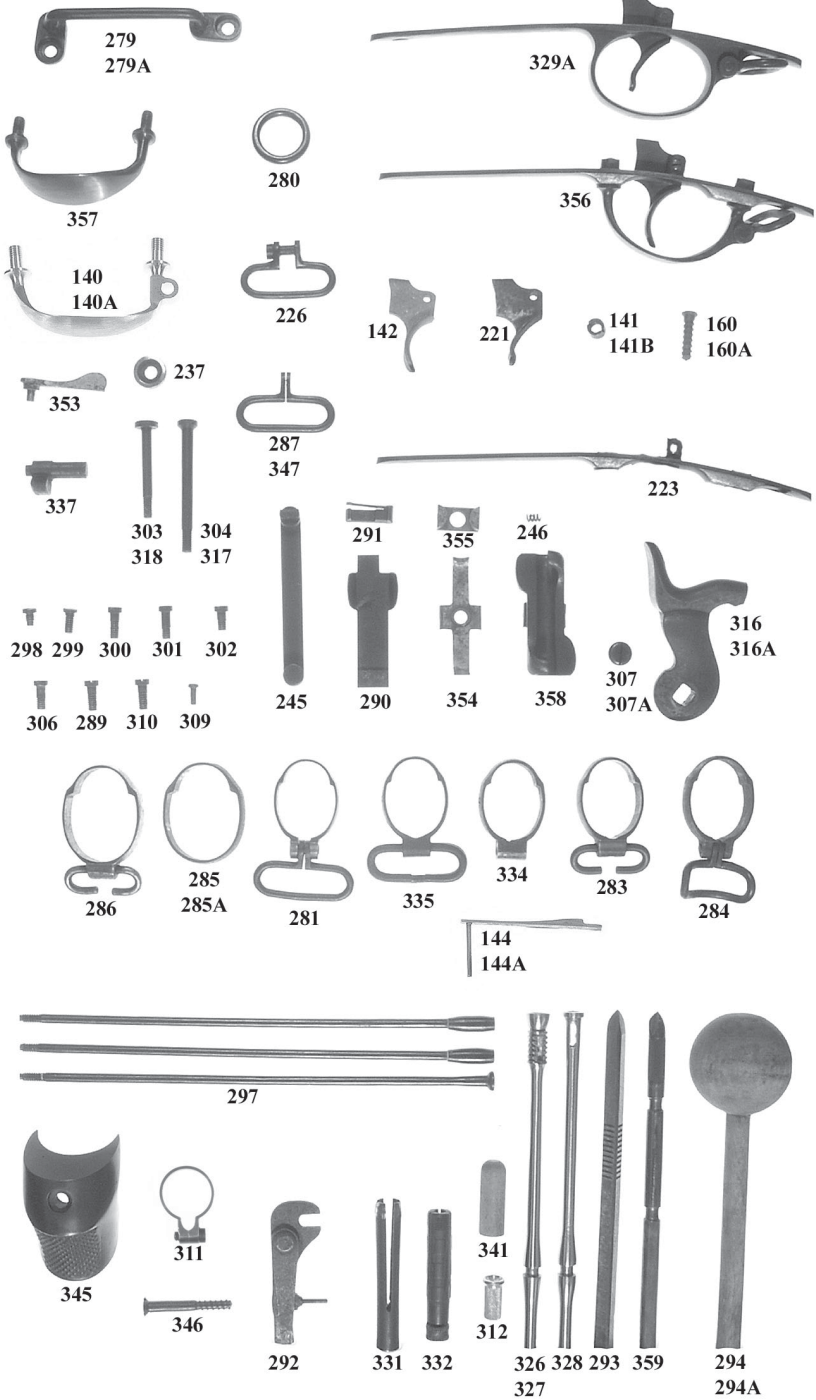

## 1873-1889 SPRINGFIELD

73S250	M1877 SPRINGFIELD REAR SIGHT, CARBINE. Marked C on Base, 600 Yards .....	90.00
73S251	M1878 REAR SIGHT, RIFLE, Complete .....	125.00
73S253	M1880 SPRINGFIELD MARKSMAN REAR SIGHT. Graduated Windage On Drift .....	175.00
73S255	M1873 REAR SIGHT BASE, RIFLE .....	30.00
73S256	M1873 REAR SIGHT LADDER, RIFLE .....	35.00
73S257	M1873 REAR SIGHT ELEVATION BAR, RIFLE, REAR PLATE .....	5.00
73S257A	M1873 REAR SIGHT ELEVATION BAR, CARBINE, REAR PLATE .....	6.00
73S258	M1877 REAR SIGHT BASE, RIFLE, Notched Steps .....	30.00
73S259	M1877 REAR SIGHT BASE, RIFLE, Smooth .....	30.00
73S260	M1877 REAR SIGHT LADDER, RIFLE .....	35.00
73S261	M1877 REAR SIGHT BASE, CARBINE .....	45.00
73S262	M1877 REAR SIGHT LADDER, CARBINE .....	40.00
73S264	M1878 REAR SIGHT BASE, RIFLE .....	30.00
73S265	M1878 REAR SIGHT ELEVATION BAR TOP PLATE, Form 1 .....	15.00
73S266	M1878 REAR SIGHT ELEVATION BAR TOP PLATE, Form 2 .....	15.00
73S266A	M1878 BOTTOM PLATE .....	12.00
73S266B	M1878 ELEVATION BAR SPRING .....	10.00
73S266C	M1878 ELEVATION BAR GIBB, Repro .....	12.00
73S266D	M1878 ELEVATION BAR TOP PLATE SCREW (Repro) .....	6.00
73S267	M1882 EXPERIMENTAL CARBINE REAR SIGHT LADDER, "XC" .....	95.00
73S269	M1884-1889 REAR SIGHT WINDAGE SCREW KNOB .....	12.00
73S270	M1884-1889 REAR SIGHT ELEVATION SLIDE SCREW .....	15.00
73S271	M1884 GEAR DRIVEN ELEVATION ASSEMBLY (Knob) .....	15.00
73S272A	M1873-1889 REAR SIGHT JOINT PIN .....	10.00
73S273	M1873 REAR SIGHT BASE SCREW, Slotless (Reproduction) .....	5.00
73S274	M1878 REAR SIGHT BASE SCREW, Slotted (Reproduction) .....	5.00
73S275	M1884-1889 REAR SIGHT BASE SCREW, Front .....	7.00
73S276	M1884-1889 REAR SIGHT BASE SCREW, Rear (Reproduction) .....	5.00
73S277	M1883 GLOBE FRONT SIGHT HOOD, RIFLE .....	45.00
73S278	M1884 FRONT SIGHT AND HOOD ASSEMBLY, Rod Bayonet .....	90.00
73S279	SWIVEL BAR, CARBINE .....	150.00
73S279A	SWIVEL BAR, CARBINE (Reproduction) .....	55.00
73S280	SADDLE BAR RING, CARBINE (Reproduction) .....	5.00
73S281	UPPER BAND, RIFLE, M1873, Complete With Reproduction Swivel .....	45.00
73S283	UPPER BAND, CADET, Complete .....	60.00
73S284	UPPER BAND, M1882 EXPERIMENTAL, CARBINE, Complete .....	100.00
73S285	M1884-1888 LOWER BAND, RIFLE AND CARBINE, Notched for Buffington sight .....	45.00
73S285A	M1873-1879 LOWER BAND, RIFLE AND CARBINE .....	65.00
73S286	M1873 CARBINE BAND WITH STACKING SWIVEL .....	80.00
73S287	M1873 UPPER SLING SWIVEL (Reproduction) .....	10.00
73S289	M1873 SWIVEL SCREW .....	3.00
73S290	M1880 EXPERIMENTAL RIFLE RAMROD CATCH SPRING .....	40.00
73S291	M1880 EXPERIMENTAL RIFLE RAMROD SPLIT CATCH .....	32.00
73S292	M1879 COMBINATION TOOL .....	15.00
73S293	M1880 EXPERIMENTAL RIFLE TRIANGULAR RAMROD BAYONET .....	200.00
73S294	GOVERNMENT ISSUE WOOD WIPING ROD, RIFLE .....	35.00
73S294A	CARBINE CLEANING ROD, Very Limited Quantity .....	65.00
73S297	3 PIECE STEEL CLEANING ROD, CARBINE (Reproduction) .....	50.00
73S298	FIRING PIN RETAINING SCREW .....	5.00
73S299	CAM LATCH SCREW .....	4.00
73S300	BRIDLE SCREW .....	3.00
73S301	SEAR SCREW .....	3.00
73S302	SEAR SPRING SCREW .....	3.00
73S303	SIDE PLATE (LOCKPLATE) SCREW (Reproduction) .....	6.00
73S304	TANG SCREW (Reproduction) .....	6.00
73S306	SLING SWIVEL SCREW (Trigger Bow) .....	3.00
73S307	HAMMER SCREW (Reproduction) .....	5.00
73S307A	HAMMER SCREW .....	10.00
73S309	TRIGGER SCREW .....	3.00
73S310	BAYONET LOCKING RING SCREW .....	3.00
73S311	BAYONET LOCKING RING, With Screw .....	25.00
73S312	M1889 ROD BAYONET TULIP TIP (Fine Quality Reproduction) .....	16.00
73S316	1884 HAMMER .....	55.00

## 1873-1889 SPRINGFIELD

73S316A	1873 HAMMER, Coarse Checkering (Reproduction) .....	40.00
73S317	TANG SCREW .....	18.00
73S318	SIDE PLATE SCREW .....	18.00
73S319A	BUTT PLATE WOOD SCREW, Top, Short For Buttplates With Trap .....	8.50
73S321	M1878 BUTTPLATE WITH TRAP, Complete .....	130.00
73S322	LOCKPLATE, Marked U.S. SPRINGFIELD, With Eagle .....	80.00
73S326	M1873 RAMROD, 1st TYPE (1873) (Reproduction).....	45.00
73S327	M1873 RAMROD, 2nd TYPE (1874) Cupped Tip (Reproduction) .....	45.00
73S328	M1884 RAMROD (Reproduction) .....	45.00
73S329A	M1888 TRIGGER BOW ASSEMBLY, Complete With Trigger And Swivel .....	90.00
73S331	M1873 HEADLESS SHELL EXTRACTOR .....	15.00
73S332	M1882 HEADLESS SHELL EXTRACTOR .....	15.00
73S333	BUFFINGTON REAR SIGHT BASE SPRING .....	9.00
73S334	UPPER BAND, Fencing Model, Swivels Milled Off .....	20.00
73S335	UPPER BAND, M1878-1890, Complete With Swivels .....	45.00
73S336	TUMBLER, Fencing Model, Hammer Square Milled Off .....	30.00
73S337	CAM LATCH, Fencing Model, Thumbpiece Milled Off .....	10.00
73S339	1873 CARBINE REAR SIGHT, Complete .....	160.00
73S340	BUTTPLATE TRAP COVER .....	30.00
73S341	45/70 HOLLOW WOOD CARTRIDGE HEAD. For Use With Birdshot. Govt Issue .....	7.50
73S342	TRAINING MAINSPRING, Reduced Tension .....	20.00
73S343	FRONT SIGHT PIN, CARBINE (Reproduction) .....	3.00
73S344	FRONT SIGHT PIN, RIFLE (Reproduction).....	3.00
73S345	PISTOL GRIP, Cast Steel (Reproduction) .....	55.00
73S346	PISTOL GRIP WOOD SCREW, For Use With 73S345 (Reproduction).....	8.00
73S347	UPPER BAND SLING SWIVEL, Original .....	17.00
73S348	CARBINE FRONT SIGHT BASE (Reproduction) .....	20.00
73S349	CARBINE FRONT SIGHT BLADE, Extra Tall (Reproduction) .....	15.00
73S350	BUFFINGTON SLIDE (Reproduction) .....	35.00
73S351	RIFLE FRONT SIGHT BLADE, Extra Tall (Reproduction).....	15.00
73S352	1873-1878 REAR SIGHT BASE SPRING (Reproduction) .....	16.00
73S352A	1873-1878 REAR SIGHT BASE SPRING, Original .....	30.00
73S353	MEDCALFE DEVICE LEVER, Original Spfld Army, Req's Final Polish and Blue, Scarce .....	70.00
73S354	M1884 RAMROD BAYONET CATCH, Early Model .....	15.00
73S355	M1888 RAMROD BAYONET CATCH SWIVEL .....	6.00
73S356	M1873-1884 RIFLE TRIGGER BOW ASSEMBLY COMPLETE, Original .....	80.00 - 120.00
73S357	M1873-1884 CARBINE TRIGGER BOW (Reproduction) .....	25.00
73S358	M1888 RAMROD CATCH .....	35.00
73S359	M1888 RAMROD, Original .....	95.00 - 125.00
73S360	M1873-1888 RECEIVERS .....	Call For Availability and Price
73S361	BUFFINGTON SIGHT LADDER, STRIPPED .....	30.00
BKA035	1873 HEADLESS SHELL EXTRACTOR INSTRUCTIONS, See Book Section for Details	
BKA036	1882 HEADLESS SHELL EXTRACTOR INSTRUCTIONS, See Book Section for Details	
BKA050	45/70 SPRINGFIELD MANUAL, See Book Section for Details	
L25	45/70 TRAPDOOR SPRINGFIELD SLING. Leather w/ brass claw, button, leather keepers ..	25.00

## REMINGTON LEE

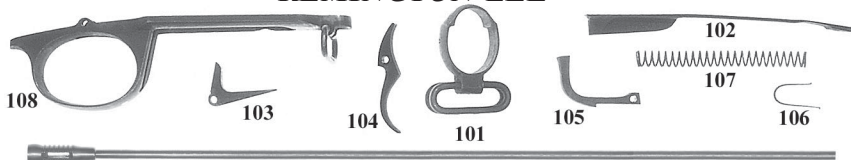

RL101	TOP BAND WITH SWIVELS .....	35.00
RL102	CARTRIDGE GUIDE/CUTOFF .....	40.00
RL103	SEAR .....	25.00
RL104	TRIGGER .....	20.00
RL105	MAGAZINE RELEASE .....	20.00
RL106	SEAR SPRING .....	25.00
RL107	MAINSRING .....	10.00
RL108	TRIGGER GUARD, M1879 With Cook Magazine Cutout .....	75.00
RL110	CLEANING ROD, Knurled Top With Slot, Threaded End, Repro .....	45.00
BKA183	REMINGTON LEE RIFLE, Excellent Book on this gun, See book section for details	



## 1892-1899 SPRINGFIELD

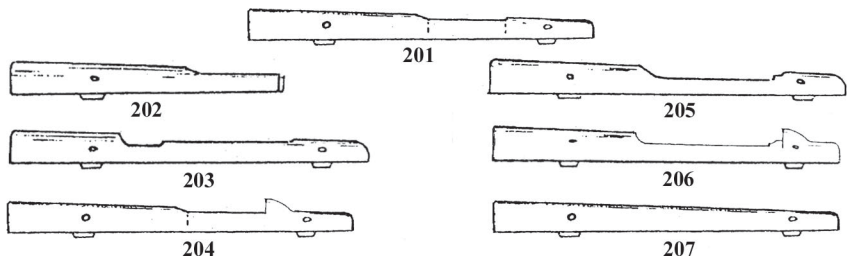

### 1892-1901 U. S. SPRINGFIELD (Krag) HANDGUARDS

American walnut, Precision machined. Requires Stain & Oil. All handguards have riveted spring attaching clips Installed.

HG201	M1896 RIFLE HANDGUARD For M1896 Sight	90.00
HG202	M1896 CARBINE HANDGUARD For M1896 Sight	90.00
HG203	M1898 RIFLE AND CARBINE HANDGUARD, For 1898-1902 Sight	90.00
HG204	M1899 CARBINE, For 1896 Sight, With Hump	90.00
HG205	M1898-1901 RIFLE HANDGUARD For M1901 Sight	90.00
HG206	M1899 HANDGUARD, For M1901 Sight, With Hump	90.00
HG207	RIFLE AND CARBINE HANDGUARD, Not Inletted For Sight, W/ Clips, For Sporter	90.00

NOTE- HG201 Can Be Used With M1892 Sight On M1894 Krag If Cut To Shorter Length At Rear

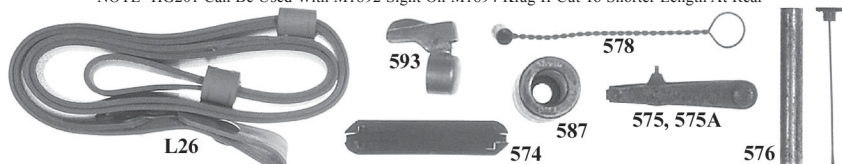

K501	CUT OFF, M1892, Flat Spring, Complete	18.00
K502	CUT OFF, M1896, Stripped	12.00
K504	CUT OFF DETENT, M1896-1899	3.00
K505	GUIDE LIP	3.00
K506	FIRING PIN ROD With Cocking Piece, Rifle	35.00
K507	FIRING PIN ROD Without Cocking Piece, Rifle or Carbine	6.00
K508	MAINSRING, M1892	8.00
K509	MAINSRING, M1896-1899	8.00
K510	EXTRACTOR, M1896-1898, Complete with spring	45.00
K511	EXTRACTOR SCREW, M1892	4.00
K512	EXTRACTOR SPRING, M1892-1899	20.00
K513	SAFETY LOCK, M1892, will not fit M1896 or M1898	15.00
K514	EJECTOR PIN, M1896-1899	5.00
K514A	EJECTOR PIN, M1892-1894	25.00
K515	EJECTOR (Reproduction)	35.00
K517	SIDE PLATE, M1896-1899	35.00
K518	SIDE PLATE SCREW (Reproduction)	5.00
K519	GATE, M1892-1896	45.00
K520	GATE, M1898-1899	45.00
K521	CARRIER, Stripped	20.00
K522	FOLLOWER	8.00
K523	FOLLOWER PIN	3.00
K524	FOLLOWER SPRING (Magazine Spring)	42.00
K525	TRIGGER	25.00
K526	FRONT SIGHT BASE, Slotted And Drilled For Blade (Reproduction)	35.00
K527	FRONT SIGHT BLADE (Reproduction)	15.00
K527A	FRONT SIGHT BLADE, Extra Tall (Reproduction)	15.00
K527B	FRONT SIGHT BLADE, Original	25.00
K528	BUTT PLATE, M1892	25.00
K529	BUTT PLATE CAP, M1896-1902	9.00
K530	BUTT PLATE CAP SPRING	4.00
K531	BUTT PLATE CAP SPRING SCREW	3.00
K534	UPPER BAND, M1894-1902, Stripped	85.00
K535	UPPER BAND SCREW (Reproduction)	6.00
K536	STACKING SWIVEL SCREW (Reproduction)	6.00

# 1892-1899 SPRINGFIELD

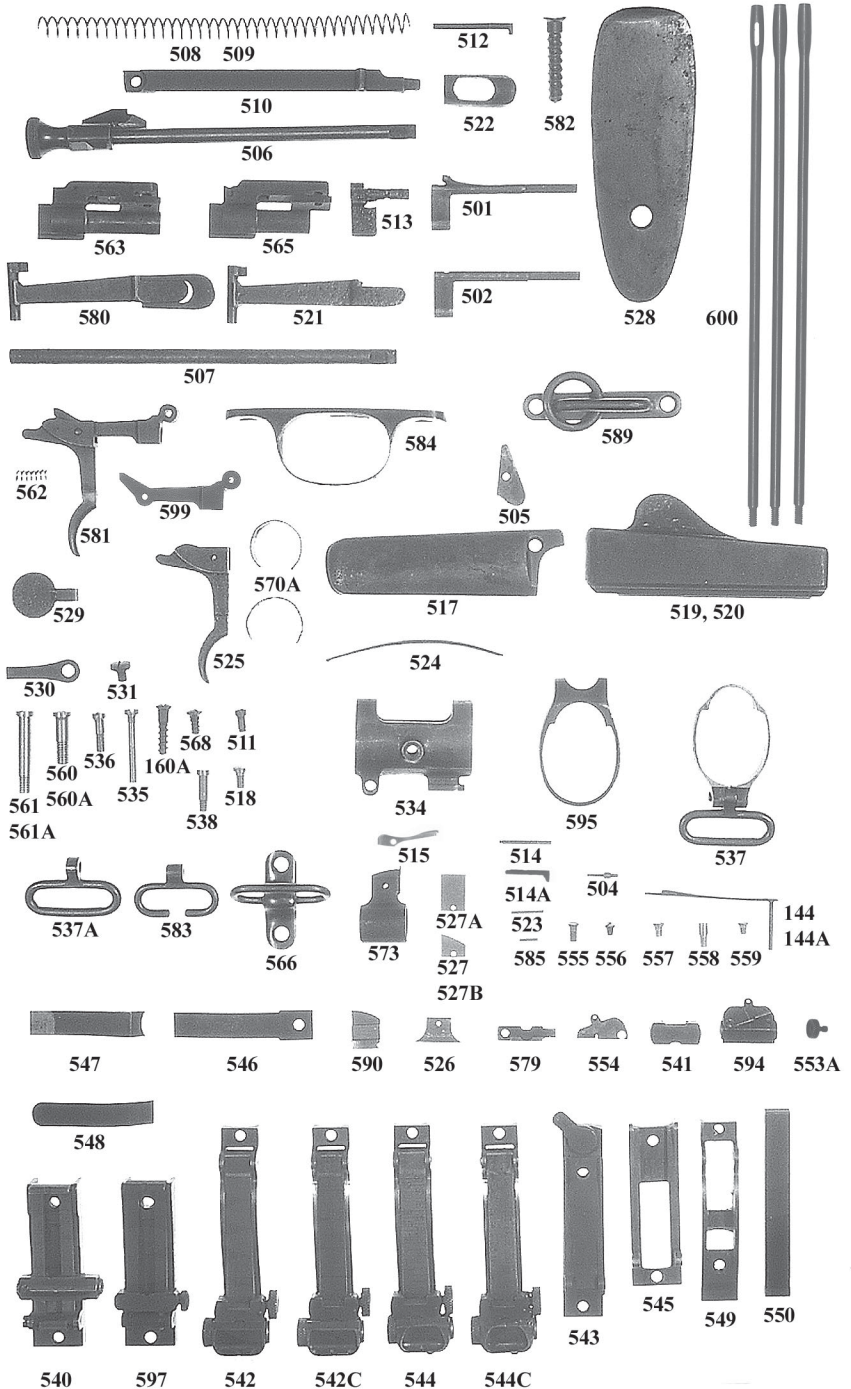

## 1892-1899 SPRINGFIELD

K537	LOWER BAND, Rifle, Complete With Sling Swivel .....	75.00
K537A	LOWER BAND SWIVEL, Blued (Reproduction) .....	12.00
K538	LOWER BAND SWIVEL SCREW .....	6.00
K540	REAR SIGHT, Rifle, M1892, Complete .....	50.00
K541	M1898, 1902 REAR SIGHT ELEVATION BAR, Stripped .....	4.00
K542	REAR SIGHT, Rifle, M1898, Complete .....	75.00
K542C	1898 CARBINE REAR SIGHT, Reworked From Rifle Sight & Stamped "C" .....	95.00
K543	REAR SIGHT, Rifle, M1901, Complete Except For Elevation Bar and Ladder .....	35.00
K544	REAR SIGHT, Rifle, M1902, Complete (Tangent Peep Model) .....	75.00
K544C	1902 CARBINE REAR SIGHT, Reworked From Rifle Sight & Stamped "C" .....	95.00
K545	REAR SIGHT BASE, M1892 .....	10.00
K546	REAR SIGHT SPRING, M1892-1896 .....	10.00
K547	REAR SIGHT SPRING, M1898 .....	10.00
K548	REAR SIGHT SPRING, M1902 .....	10.00
K549	REAR SIGHT BASE, M1898, Rifle .....	10.00
K550	REAR SIGHT LADDER, Rifle, M1898, Stripped .....	11.00
K553	M1901 REAR SIGHT ELEVATION BAR SCREW .....	5.00
K553A	M1901 REAR SIGHT ELEVATION BAR LOCKING KNOB, Repro .....	12.50
K554	M1902 REAR SIGHT TANGENT PEEP PLATE .....	3.00
K555	M1892-1896 SIGHT SCREW, Front, Long (Reproduction) .....	5.00
K555A	M1892-1896 SIGHT SCREW, Front, Long, Original .....	6.00
K556	M1892-1896 SIGHT SCREW, Rear, Short (Reproduction) .....	5.00
K557	M1898 AND M1902 SIGHT SCREW, Front And Rear (Reproduction) .....	5.00
K558	M1901 SIGHT SCREW, Front, Long (Reproduction) .....	6.00
K559	M1901 SIGHT SCREW, Rear, Short (Reproduction) .....	5.00
K560	TRIGGER GUARD SCREW, Front, Short (Reproduction) .....	6.00
K560A	TRIGGER GUARD SCREW, Front, Short .....	12.00
K561	TRIGGER GUARD SCREW, Rear, Long (Reproduction) .....	6.00
K561A	TRIGGER GUARD SCREW, Rear, Long .....	12.00
K562	SEAR SPRING .....	3.00
K563	SLEEVE, M1892, Stripped .....	20.00
K563A	1892 SLEEVE with Safety and Safety Pin .....	40.00
K564	SLEEVE, M1892 As Modified To M1896, Stripped .....	20.00
K565	SLEEVE, M1896-M1899, Stripped .....	20.00
K566	BUTT SWIVEL .....	35.00
K568	SADDLE BAR WOOD SCREW .....	4.00
K570A	HANDGUARD FASTENING CLIPS, Front & Rear, Set of 2 (1 of each), Reproduction .....	10.00
K573	MOVABLE FRONT SIGHT, Major Parker's Patent, Rifle .....	85.00
K574	PARKHURST QUICK LOADING CLIP .....	150.00
K575	M1897 COMBINATION TOOL, Minor Pitting .....	90.00
K575A	M1897 COMBINATION TOOL (Reproduction) .....	30.00
K576	OILER, M1896-1899, With Screw Top And Applicator .....	17.50
K578	POWDER MEASURE, For Reloading Set, Twisted Wire Handle .....	17.00
K579	M1901 REAR SIGHT ELEVATION BAR TOP PLATE .....	7.00
K580	CARTRIDGE FOLLOWER, Complete .....	40.00
K581	TRIGGER AND SEAR, With Pin Assembly .....	45.00
K582	BUTTPLATE WOOD SCREW, Back Position, Large .....	8.50
K583	STACKING SWIVEL, Blued (Reproduction) .....	12.00
K584	TRIGGER GUARD .....	40.00
K585	FRONT SIGHT BLADE RETAINING PIN (Reproduction) .....	3.00
K587	STEEL LOADING ANVIL FROM FRANKFORD ARSENAL RELOADING SET .....	20.00
K589	CARBINE SADDLE BAR WITH RING (Reproduction) .....	65.00
K590	POPE-STEVENS KRAG .22 CALIBER FRONT SIGHT (Reproduction) .....	35.00
K593	BRASS MUZZLE COVER, REPRO OF SPFLD ARMORY ORIGINAL ISSUE .....	32.00
K594	M1902 REAR WINDAGE PEEP SIGHT ASSY, Complete with peep plate and screw .....	12.00
K595	1896 CARBINE BAND, Blued (Reproduction) .....	65.00
K596	M1896 CANVAS BREECH COVER, Stenciled with Tie strings as original (Reproduction) .....	25.00
K597	M1896 CARBINE REAR SIGHT, Complete, Blued (Reproduction) .....	110.00
K599	SEAR, All models .....	25.00
K600	3 PIECE CLEANING ROD SET, Fits in Rifle Buttstock (Reproduction) .....	50.00
L26	SLING, Leather with Brass Hook and Keepers, (Reproduction) .....	25.00
58S144	BAND SPRING .....	25.00
58S144A	BAND SPRING, (Reproduction) .....	10.00
58S160A	BUTT PLATE TOP WOOD SCREW, (Reproduction) .....	3.00
58S160A	BUTT SWIVEL WOOD SCREW, (Reproduction) .....	3.00
BKA052	U.S.KRAG MANUAL, See book section for complete description	

# LEE NAVY

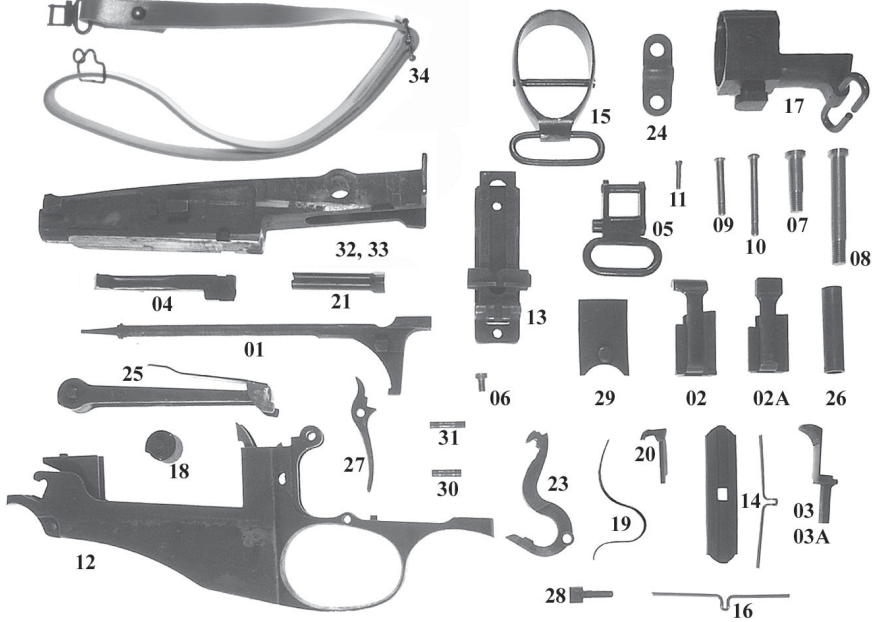

LN1	FIRING PIN .....	25.00
LN2	BOLT STOP, 1 <sup>st</sup> Pattern, Smooth .....	24.00
LN2A	BOLT STOP, 2nd Pattern, Checkered .....	24.00
LN3	FIRING PIN LOCK .....	25.00
LN3A	FIRING PIN LOCK, Roller Style .....	30.00
LN4	EXTRACTOR, With Spring (Reproduction) .....	65.00
LN5	DETACHABLE SLING SWIVEL (Reproduction) .....	22.00
LN6	SIGHT SCREW (Reproduction) .....	5.00
LN7	TRIGGER GUARD SCREW, Front (Repro) .....	7.00
LN8	TRIGGER GUARD SCREW, Rear (Repro) .....	7.00
LN9	TOP BAND SCREW (Repro) .....	5.00
LN10	LOWER BAND SCREW (Repro) .....	5.00
LN11	FRONT SIGHT HOOD SCREW (Repro) .....	5.00
LN12	TRIGGERGUARD, Stripped .....	25.00
LN13	REAR SIGHT .....	135.00
LN14	CARTRIDGE CLIP WITH WIRE (Reproduction) .....	35.00
LN15	LOWER BAND With Swivel & Screw (Reproduction) .....	55.00
LN16	WIRE FOR CARTRIDGE CLIP, Commonly Missing (Reproduction) .....	9.50
LN17	TOP BAND With Lug & Swivel (Reproduction) .....	95.00
LN18	CARTRIDGE LIFTER COIL SPRING With Shaft .....	55.00
LN19	SEAR SPRING .....	42.00
LN20	SEAR FLY (Reproduction) .....	47.00
LN21	FIRING PIN COLLAR (Reproduction) .....	48.00
LN23	SEAR .....	25.00
LN24	BUTTSTOCK SWIVEL BASE .....	40.00
LN25	CARTRIDGE FOLLOWER, Complete .....	80.00
LN26	STOCK FERRULE .....	5.00
LN27	TRIGGER .....	25.00
LN28	FIRING PIN LOCK, Lock Pin .....	32.00
LN29	BUTTPLATE TRAP SLIDE .....	45.00
LN30	SEAR PIVOT PIN .....	3.00
LN31	TRIGGER PIVOT PIN .....	3.00
LN32	BOLT BODY .....	150.00
LN33	BOLT BODY, Missing Gas Shield .....	75.00
LN34	SLING, Brown Leather, Complete with all Hardware and Detachable Swivel, Reproduction ..	65.00
BKA051	MANUAL, Gov't Issue, Illustrated, Reprint, See Book Section For Complete Description	

## LEE NAVY



HS20	1895 6MM LEE NAVY BAYONET SCABBARD HANGER. Formed Brass Wire. Repro .....	6.00
HS21	M1895 6MM LEE NAVY SUSPENDER HARDWARE KIT. Consists Of 4 Hooks And 2 Adjusting Slide Buckles. Brass, Reproduction .....	12.00
HS22	M1895 6MM LEE NAVY WEB BELT PATENT TAG. Stamped Tin With Attaching Prongs. Also Used On Mills Web Equipment. ....	3.00
HS23	M1895 6MM LEE NAVY CARTRIDGE BELT "C" CLOSURE. Formed Brass, Repro .....	6.00
L22	1895 6MM WINCHESTER LEE NAVY SUSPENDER SET. 2 Blue Web Shoulder Straps w/ Ends Edged w/ Sewn Leather & HS21 Hardware kit. Unassembled, rivets not included .....	25.00

## 1903 SPRINGFIELD

03RB10	PRE-1908 CLEANING PULL THRU, Bristle Brush, Brass Weight, Cord, First Issue .....	40.00
03S1	M1922-M1 FIRING PIN STRIKER .....	65.00
03S2	M1922-M1 EXTRACTOR .....	45.00
03S3	M1922-M2 COCKING PIECE .....	40.00
03S4	M1922-M2 FIRING PIN NUT .....	40.00
03S5	M1922-M2 FIRING PIN NUT LOCKING SPRING .....	10.00
03S6	1903 STRIKER, Firing Pin Tip .....	8.00
03S7	1903 REAR SIGHT BASE SPRING .....	5.00
03S8	FRONT SIGHT BLADE, USMC style, (Reproduction) .....	32.00
03S8A	REAR SIGHT SLIDE USMC SPECS, Use With 03S8, (Reproduction) .....	38.00
03S9	FRONT SIGHT BLADE, Unmarked .....	4.00
03S10	M1903 FRONT SIGHT BLADE marked "A" .....	8.00
03S11	M1903 FRONT SIGHT BLADE PIN .....	3.00
03S13	M1903 STACKING SWIVEL (Repro) .....	10.00
03S14	M1903 BOLT, Stripped .....	35.00
03S16	M1903 REAR SIGHT MOVABLE BASE .....	8.00
03S17	M1903 REAR SIGHT LADDER, Stripped .....	6.00
03S19	M1903-A3 BAND SPRING, Stamped .....	4.00
03S20	M1903-A3 TRIGGER GUARD .....	20.00
03S22	M1903 BRASS CARTRIDGE CLIP, WWI Issue .....	6.00
03S23	M1903 SLING KEEPER, Leather, Sewn, Set of 2 .....	4.00
03S24	1908 THRU EARLY 1940 CLEANING PULL THRU, Bristle Brush, Brass Weight, Cord .....	7.00
03S25	M1903 1000" AIMING DEVICE STRIKER, Screws On Rod Assy to Pierce Target .....	5.00
03S27A	BUTTSTOCK SWIVEL AND BASE, Stamped .....	8.00
03S28	FIRING PIN SLEEVE .....	3.00
03S29	FIRING PIN STRIKER .....	10.00
03S30	BOLT SLEEVE .....	20.00
03S31	BOLT STOP SPRING AND PIN .....	8.00
03S33	REAR SIGHT LEAF .....	6.00
03S35	FRONT SIGHT SCREW .....	4.00
03S36	UPPER BAND SCREW (Repro) .....	6.00
03S38	MAGAZINE FOLLOWER SPRING .....	4.00
03S39	GRENADE LAUNCHER SHIM, STAMPED STEEL .....	5.00
03S40	HANDGUARD CLIPS .....	2.00
03S41	FIRING PIN MAINSPRING .....	6.00
03S42	EXTRACTOR .....	18.00
03S43	1905 - WWI LOWER BAND SWIVEL .....	25.00
03S44	1903 STACKING SWIVEL .....	15.00
03S60	03A3 LOWER BAND SWIVEL .....	5.00
03S61	03A3 STACKING SWIVEL .....	5.00
03S62	REAR TIGGER GUARD SCREW, Long (Repro) .....	5.00
03S62A	REAR TIGGER GUARD SCREW, Long, used .....	5.00
03S63	FRONT TRIGGER GUARD SCREW, Short (Repro) .....	5.00
03S63A	FRONT TRIGGER GUARD SCREW, Short, used .....	5.00
03S64	SEAR, Pre WWI .....	8.00
03S64A	SEAR, WWI - WWII .....	5.00
03S64B	SEAR, Wartime Contract .....	5.00
03S65	MAGAZINE FOLLOWER, Milled .....	10.00
03S66	MAGAZINE FOLLOWER, Stamped .....	5.00
03S67	TRIGGERGUARD FLOORPLATE .....	18.00

## 1903 SPRINGFIELD

03S68	TRIGGERGUARD FLOORPLATE CATCH .....	5.00
03S69	EJECTOR .....	7.00
03S70	SAFETY .....	6.00
03S71	CUTOFF .....	10.00
03S72	TRIGGERGUARD STOCK FERRULE .....	3.00
03S73	SEAR SPRING .....	2.00
03S74	CUTOFF SPINDLE .....	3.00
03S80	FRONT SIGHT BASE, 03A3, used .....	6.00
03S81	FRONT SIGHT BASE, 1903, used .....	6.00
BKA054	GOV'T MANUAL FOR THIS RIFLE, ALSO SEE BKA055 IN BOOK SECTION	
HG211	M1903 HANDGUARD .....	20.00
L56	1903 SPRINGFIELD LEATHER SLING (Reproduction) .....	25.00

**NOTE: Additional 1903 Parts Available, Please Inquire. See Book Section For Many Titles on the 03 Springfield**

## 1903-1908 TELESCOPIC SIGHT

03S49	Prism Lens, Large Pyramid Shape .....	30.00
03S50	Objective Lens. ....	10.00
03S51	Eyepiece Lens. ....	10.00
03S52	Objective Lens Holder. ....	25.00
03S53	Eyepiece Lens Holder. ....	25.00
03S54	Catch. ....	35.00
03S55	M1904 Pan Sight, Field Lens. ....	10.00
03S56	Model 1904 Pan Sight Eye Lens. ....	10.00
03S58	Prism Housing. ....	125.00
BKA057	Gov't Manual On 1908-1913 Telescopic Sight, See Book Section For More Information	

## 1903 MATCH RIFLE

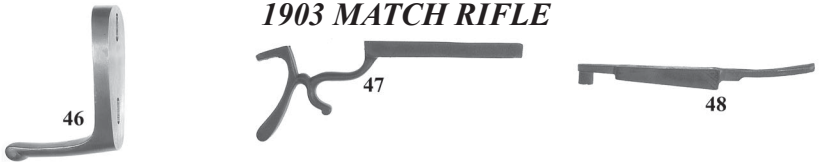

1930 International Match Rifle Parts: Ref. 1903 Springfield by Brophy, pp. 114-120, 132-134. These parts are the design of Col. McDougal (USMC) and were used on the 1903 International Match Rifles.

03S46	Butt Plate With Hook, Aluminum, 1924 Match Rifle .....	95.00
03S47	Trigger Guard With Finger Stall .....	200.00
03S48	Trigger Plate And Magazine Box Bottom .....	150.00

## 1903 ROD BAYONET SPRINGFIELD

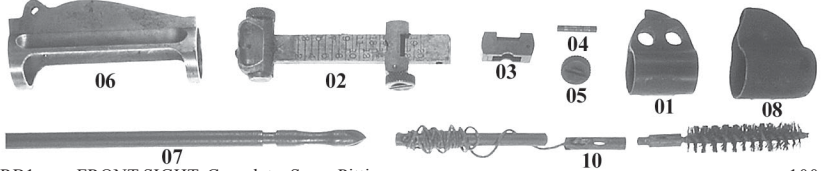

03RB1	FRONT SIGHT, Complete, Some Pitting .....	100.00
03RB2	REAR SIGHT LEAF .....	35.00
03RB3	REAR SIGHT ELEVATION BAR .....	4.50
03RB4	REAR SIGHT JOINT PIN .....	3.00
03RB5	REAR SIGHT ELEVATION BAR RETAINING SCREW .....	8.00
03RB6	MODEL 1901 SIGHT BASE, Stripped .....	65.00
03RB7	RAMROD BAYONET .....	200.00
03RB8	FRONT SIGHT HOOD .....	60.00
03RB10	PRE-1908 CLEANING PULL THRU, Bristle Brush, Brass Weight, Cord, 1st Issue .....	42.00
BKA053	GOV'T MANUAL ON THE ROD BAYONET, See book section for complete description	

## 1917 U.S. ENFIELD

03S75	FRONT TRIGGER GUARD SCREW (Repro) .....	5.00
03S76	REAR TRIGGER GUARD SCREW (Repro) .....	5.00
03S77	FRONT SIGHT BLADE, Specify desired height, 0, 015, 030, 045, 075, 090, 105 .....	8.00
03S77A	FRONT SIGHT BASE, With Insert .....	19.00
03S78	BOLT STOP SPRING .....	15.00
BKA067	GOV'T MANUAL FOR 1917 U.S. ENFIELD, See Book Section For More Information	

## REMINGTON ROLLING BLOCK

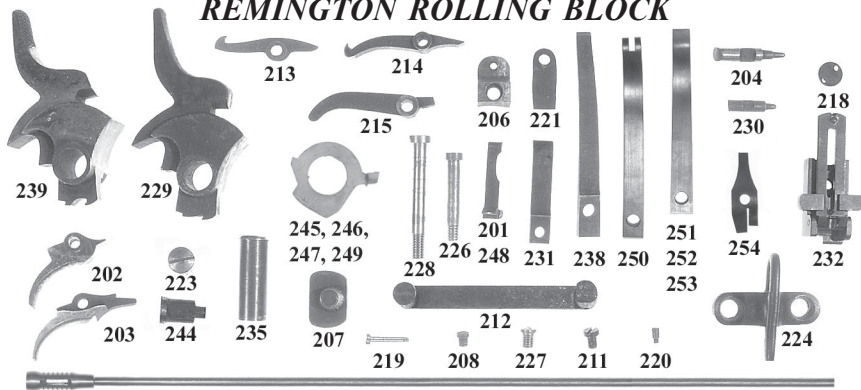

### 300. 301. 302

GS149	BUTTSTOCK, 1871 Army, Can be fitted to others (Reproduction) .....	60.00
GS149A	FOREND, 29.5 inches long, Copy of .43 Spanish, Can be adapted to others (Reproduction) ..	50.00
RBHG	HANDGUARD, Late Models (Reproduction) .....	85.00
RB201	EXTRACTOR, Navy Model, Linear .....	25.00
RB202	TRIGGER, Navy Model .....	18.00
RB203	TRIGGER, Army and New York State Model .....	18.00
RB204	FIRING PIN, Navy Model .....	18.00
RB206	BARREL BLOCK (Recoil Block), All Models .....	10.00
RB207	RAMROD STOP, All Models .....	6.00
RB208	TRIGGER SPRING SCREW, Army, Navy .....	4.00
RB211	NOSE CAP SCREW, All Models (Reproduction) .....	4.00
RB212	RAMROD CATCH, Navy Model .....	8.00
RB213	LOCKING LEVER, Navy Model .....	20.00
RB214	SEAR, Army Model .....	20.00
RB215	LOCKING LEVER, Army Model .....	20.00
RB218	REAR SIGHT BASE SCREW, Army, Navy .....	5.00
RB219	REAR SIGHT CROSS SCREW Army, Navy (Reproduction) .....	5.00
RB220	REAR SIGHT ELEVATION BAR RETAINING SCREW, Army, Navy .....	4.00
RB221	REAR SIGHT SPRING, Army, Navy .....	7.00
RB223	FRAME SCREW, Lower .....	6.00
RB224	BUTT STOCK SLING SWIVEL .....	35.00
RB226	TRIGGER GUARD TO FRAME SCREW (Repro) .....	7.00
RB227	RETAINING PLATE SCREW (Repro) .....	4.00
RB228	TANG SCREW (Repro) .....	6.00
RB229	HAMMER, Various Models Available, Send Tracing Or Photo Copy .....	30.00
RB230	FIRING PIN, Small Frame Actions .....	12.00
RB231	TRIGGER SPRING .....	16.00
RB232	REAR SIGHT, ARMY MODEL (Reproduction) .....	55.00
RB235	HAMMER & BREECH BLOCK PIVOT PIN, Large Frame .....	15.00
RB238	MAINSRING, Single Shot Pistol .....	42.00
RB239	U.S. NAVY MODEL HAMMER, 50/70, MINT, UNISSUED .....	80.00
RB244	RETAINING SHAFT FOR FIRING PIN, Comes Off Of Rotary Extractor .....	25.00
RB245	ROTARY EXTRACTOR, Cast Steel, requires final fitting (Reproduction) .....	25.00
RB246	MODEL 1 ROTARY EXTRACTOR, For use with RB244 .....	55.00
RB247	MODEL 1 ROTARY EXTRACTOR, Also fits Model 1 1/2 .....	55.00
RB248	MODEL 2 BAR EXTRACTOR .....	40.00
RB249	ROTARY EXTRACTOR, Smokeless Action, Cast Steel, Requires Final Fitting (Repro) .....	30.00
RB250	#2 MAINSPRING (Reproduction) .....	40.00
RB251	#4 MAINSPRING (Reproduction) .....	40.00
RB252	#1 MAINSPRING (Reproduction) .....	40.00
RB253	M1867-70 MAINSPRING (Reproduction) .....	45.00
RB254	#4 TRIGGER, EXTRACTOR AND BLOCK SPRING (Reproduction) .....	27.00
RB300	1879 ARGENTINE & .43 SPANISH RAMROD (Reproduction) .....	45.00
RB301	1868 DANISH RAMROD (Reproduction) .....	45.00
RB302	1871 NEW YORK STATE 50/70 RAMROD (Reproduction) .....	45.00
BKA029	1870 USN ROLLING BLOCK MANUAL, See book section for complete description	
BKA030	1871 U.S. ARMY ROLLING BLOCK PISTOL MANUAL, See book section for description	
BKA360	REM ROLLING BLOCK MILITARY RIFLES OF THE WORLD, See book section for description	

## ***ARMI-SPORT 1842 SPRINGFIELD***

ASM1	MAINSRING .....	17.00	ASM8	LOCKPLATE SCREW .....	6.00
ASM2	NIPPLE .....	6.00	ASM9	TANG SCREW .....	6.00
ASM3	BRIDLE .....	14.00	ASM10	LONG RANGE REAR SIGHT .....	95.00
ASM4	SEAR SPRING .....	12.00	ASM11	UPPER BAND SPRING .....	18.00
ASM5	SEAR .....	20.00	ASM12	MIDDLE/LWR BAND SPRING .....	18.00
ASM6	TUMBLER .....	26.00	ASM13	RAMROD .....	40.00
ASM7	HAMMER SCREW .....	6.00			

## ***ARMI-SPORT 1861 SPRINGFIELD***

ASM20	MAINSRING .....	12.00	ASM26	HAMMER SCREW .....	6.00
ASM21	NIPPLE .....	6.00	ASM27	LOCKPLATE SCREW .....	6.00
ASM22	BRIDLE .....	12.00	ASM28	TANG SCREW .....	6.00
ASM23	SEAR SPRING .....	12.00	ASM29	RAMROD .....	45.00
ASM24	SEAR .....	18.00	ASM30	BANDSPRING .....	10.00
ASM25	TUMBLER .....	26.00	ASM31	CLEAN OUT SCREW .....	4.75

## ***ARMI-SPORT ENFIELD***

ASM40	MAINSRING .....	12.00	ASM45	TUMBLER .....	26.00
ASM41	NIPPLE .....	6.00	ASM46	HAMMER SCREW .....	6.00
ASM42	BRIDLE .....	12.00	ASM47	LOCKPLATE SCREW .....	6.00
ASM43	SEAR SPRING .....	12.00	ASM48	TANG SCREW .....	6.00
ASM44	SEAR .....	15.00	ASM49	RAMROD, 3 BAND .....	42.00

## ***ARMI-SPORT SHARPS PERCUSSION***

ASM60	CLEANOUT SCREW .....	6.00	ASM62	NIPPLE .....	6.00
ASM61	LEVER SPRING .....	17.00	ASM63	.54 CHAMBER SLEEVE .....	18.00

## ***ARMI-SPORT WINCHESTER HI/LOW WALL***

ASM81	COIL MAINSPRING .....	8.50
-------	-----------------------	------

## ***UBERTI 1847 COLT WALKER***

1847-1	WALKER L/L CATCH .....	14.00
--------	------------------------	-------

## ***UBERTI 1849 POCKET***

1849-1	HAMMER .....	40.00	1849-7	WEDGE .....	20.00
1849-2	MAINSRING .....	10.00	1849-8	HANDSPRING .....	3.50
1849-3	TRIGGER .....	16.00	1849-9	LOADING LEVER LATCH .....	9.00
1849-4	HAND W/SPRING .....	20.00	1849-10	LOADING LEVER CATCH .....	9.00
1849-5	BOLT .....	18.00	1849-11	WEDGE SCREW .....	4.00
1849-6	BOLT/TRIGGER SPRING .....	8.00	1849-12	LOADING LEVER, 4 1/2 inch .....	40.00

## ***UBERTI 1851/1861 NAVY***

1851-1	HAND W/ SPRING .....	20.00	1851-5	TRIGGER .....	16.00
1851-2	WEDGE W/ SPRING, 1851 only ..	22.00	1851-6	MAINSRING .....	10.00
1851-3	CYLINDER BOLT SPRING .....	8.00	1851-7	HAMMER, 1851 only .....	44.00
1851-4	CYLINDER LOCKING BOLT .....	25.00	1849-8	HANDSPRING .....	3.50

## ***UBERTI 1858 REMINGTON***

1858-1	BOLT/TRIGGER SPRING .....	7.00	1858-4	TRIGGER .....	20.00
1858-2	HAND & SPRING .....	15.00	1858-5	MAINSRING .....	10.00
1858-3	BOLT .....	22.50	1858-6	HAMMER .....	44.00

## ***UBERTI 1860 ARMY***

1851-1	HAND & SPRING .....	20.00	1851-5	TRIGGER .....	16.00
1851-3	BOLT SPRING .....	7.00	1851-6	MAINSRING .....	10.00
1851-4	BOLT .....	25.00	1851-7	HAMMER .....	44.00

JA142	UBERTI NIPPLES, Pack of 6 .....	12.00
-------	---------------------------------	-------

WHILE NOT LISTED HERE, WE CAN SPECIAL ORDER OTHER UBERTI PARTS. PLEASE CALL OR EMAIL FOR MORE INFORMATION.



## **PIETTA 1858 REMINGTON**

PRM1	.44 ARMY HAMMER .....	40.00	PRM6	.44 ARMY TRIGGER .....	11.00
PRM2	.44 ARMY MAINSPRING .....	10.00	PRM7	.44 ARMY CYLINDER PIN .....	12.00
PRM3	.44 TRIGGER/BOLT SPRING .....	4.50	PRM8	NIPPLE, Fits most Piettas .....	3.75
PRM4	.44 ARMY HAND W/ SPRING .....	10.00	PRM9	NIPPLE, Stainless Steel .....	5.00
PRM5	.44 ARMY CYLINDER BOLT .....	15.00			

## **EUROARMS 1803 HARPERS FERRY**

HF025	FRIZZEN .....	42.00	HF225	FRIZZEN SPRING .....	20.00
HF031	SEAR .....	17.00	HF231	SEAR SPRING .....	12.00

## **EUROARMS MISSISSIPPI**

EMS03	TANG SCREW .....	6.00	EMS39	HAMMER SCREW .....	5.00
EMS04	REAR SIGHT "V" NOTCH .....	8.00	EMS40	TUMBLER .....	30.00
EMS11	FRONT BAND .....	38.00	EMS41	STIRRUP .....	5.00
EMS12	FRONT BAND SPRING .....	12.00	EMS42	STIRRUP PIN .....	3.00
EMS13	REAR BAND .....	30.00	EMS43	SEAR .....	20.00
EMS14	REAR BAND SPRING .....	12.00	EMS44	SEAR SPRING .....	12.00
EMS22	TRIGGER PLATE .....	30.00	EMS45	SEAR SPRING SCREW .....	3.00
EMS23	TRIGGER GUARD .....	25.00	EMS46	BRIDLE .....	16.00
EMS24	TRIGGER GUARD NUT .....	4.00	EMS47	BRIDLE SCREW .....	3.00
EMS25	SIDEPLATE .....	12.00	EMS48	SEAR SCREW .....	3.00
EMS27	SWIVEL SCREW .....	4.50	EMS49	MAINSRING .....	15.00
EMS28	TRIGGER .....	12.00	EMS7020	NIPPLE .....	5.00
EMS29	TRIGGER SCREW .....	3.00	EMSL	LOCK ASSY With HAMMER ...	135.00
EMS36	LOCK PLATE SCREW .....	6.00	EZR17	SWIVEL .....	12.00
EMS38	HAMMER .....	30.00			

## **EUROARMS 1863 RICHMOND**

ER03	REAR SIGHT .....	45.00	ER38	MAINSRING .....	15.00
ER04	REAR SIGHT BASE SCREW .....	5.00	ERL	LOCK ASSY. With HAMMER ...	135.00
ER19	FOREND CAP .....	11.00	ESP7020	NIPPLE .....	5.00

## **EUROARMS 1863 ZOUAVE**

EMS27	SWIVEL SCREW .....	4.50	EZR17	SWIVEL .....	12.00
EZR02-1	HAMMER SCREW .....	5.00	EZR19	REAR BAND .....	20.00
EZR03	BRIDLE SCREW .....	3.00	EZR20	TRIGGER PLATE .....	30.00
EZR04	SEAR SPRING SCREW .....	3.00	EZR24	LOCKPLATE SCREW .....	6.00
EZR05	SEAR SPRING .....	12.00	EZR38	TANG SCREW .....	6.00
EZR06	SEAR .....	20.00	EZR42	REAR SIGHT BASE SCREW .....	5.00
EZR07	SEAR SCREW .....	3.00	EZR48	REAR SIGHT .....	70.00
EZR08	BRIDLE .....	16.00	EZR49	FRONT SIGHT .....	15.00
EZR09	TUMBLER .....	30.00	EZR51	BAYONET LUG .....	20.00
EZR10	MAINSRING STIRRUP .....	5.00	EZR7020	NIPPLE .....	5.00
EZR11	MAINSRING .....	15.00	EZRL	LOCK COMPLETE .....	135.00
EZR15	FRONT BAND .....	20.00	EZRO2	HAMMER .....	30.00

## **EUROARMS COOK & BROTHERS**

ECB050	FRONT SIGHT .....	15.00	ECB100	RAMROD .....	42.00
ECB070	REAR SIGHT .....	10.00	ECB190	LOWER SWIVEL WTH STUD .....	20.00
ECB080	UPPER BAND .....	30.00	EECB15	UPPER SLING SWIVEL .....	15.00
ECB090	LOWER BAND .....	30.00			

## **NATIONAL RIFLE ASSOCIATION**

Since 1871 the NRA has worked to educate hunters, reform restrictive gun laws, and strengthen the criminal justice system. The NRA also promotes the effective wildlife management and conservation policies. Along with sanctioning about 12,000 shooting tournaments each year they also help run the National Matches at Camp Perry. Please consider joining this worthwhile organization, Their member benefits are too numerous to list here. Ask for a membership application and we will gladly provide it with your order or call the NRA toll fee at 1-800-NRA 3888.

## **EUROARMS ENFIELD**

AP302A	WORM, FITS EOA RAMRODS .....	10.00	EEM23	BRIDLE .....	16.00
EE2407RS	MUSKETOON REAR SIGHT .....	60.00	EEM24	TUMBLER .....	30.00
EE2430	MUSKETOON RAMROD 24.5" .....	42.00	EEM25	STIRRUP .....	5.00
EE3306	2 BAND BAYONET LUG .....	20.00	EEM26	SEAR .....	20.00
EE3330	2-BAND ENFIELD RAMROD 33" .....	42.00	EEM27	SEAR SPRING .....	12.00
EEM5	FRONT SIGHT .....	15.00	EEM29	ENFIELD SIDEPLATE WASHER ..	3.00
EEM7-1	REAR SIGHT BASE .....	17.00	EEM30	RAMROD, 3 Band .....	42.00
EEM7-2	REAR SIGHT LEAF .....	15.00	EEM31	SEAR SCREW .....	3.00
EEM7-3	REAR SIGHT SLIDE .....	15.00	EEM32	BRIDLE SCREW .....	3.00
EEM7-4	REAR SIGHT BASE SPRING .....	5.00	EEM33	SEAR SPRING SCREW .....	3.00
EEM7-5	REAR SIGHT SLIDE SPRING .....	5.00	EEM34	HAMMER SCREW .....	5.00
EEM7-6	SIGHTBASE SPRING SCREW .....	4.00	EEM37	BAND SCREW .....	4.50
EEM7-7	SIGHT SLIDE SPRING SCREW .....	5.00	EEM38	LOCK PLATE SCREW .....	6.00
EEM7-8	REAR SIGHT PIN .....	4.00	EEM39	TANG SCREW .....	6.00
EEM8	FRONT BAND W/O SCREW .....	35.00	EEM40	STOCK TIP SCREW .....	5.00
EEM80	MIDDLE BAND .....	30.00	EEM41	TRIGGER PLATE WOOD SCREW ..	3.00
EEM8B	FRONT SWIVEL .....	12.00	EEM150	TRIGGER GUARD SWIVEL .....	12.00
EEM9	REAR BAND W/O SCREW .....	30.00	EEM155	LOWER SWIVEL SCREW .....	4.50
EEM12	FOREND CAP .....	20.00	EEM200	REAR SIGHT COMPLETE .....	60.00
EEM13	TRIGGER PLATE .....	20.00	EEM2408	MUSKETOON TOP BAND .....	35.00
EEM14	TRIGGER GUARD .....	45.00	EEM2419	BUTT SWIVEL ASLY, Musketoon ..	20.00
EEM16	TRIGGER .....	12.00	EEM2425	NIPPLE PROTECTOR STUD .....	7.00
EEM17	BUTTPLATE .....	45.00	EEM3308	2 BAND RIFLE TOP BAND .....	35.00
EEM20	HAMMER .....	30.00	EEM7022	NIPPLE .....	5.00
EEM21	LOCKPLATE (L.A. CO.) .....	27.00	EEML	LOCK ASSY. With HAMMER ...	135.00
EEM21A	LOCKPLATE 1861 ENFIELD .....	27.00	V0031	VOLUNTEER CLEANOUT SCREW	6.00
EEM22	MAINSRING .....	15.00			

## **EUROARMS 1855/1861 SPRINGFIELD**

58S210	TRIGGER BAR ASSY, Complete ..	90.00	ESP34	RAMROD .....	45.00
AP302A	WORM, FITS EOA RAMRODS .....	10.00	ESP35	HAMMER .....	35.00
ESP02	FRONT SIGHT/BAYONET LUG ..	15.00	ESP36	HAMMER SCREW .....	5.00
ESP03	REAR SIGHT COMPLETE .....	47.00	ESP38	MAINSRING .....	15.00
ESP04	REAR SIGHT BASE SCREW .....	5.00	ESP39	TUMBLER .....	32.00
ESP10	CLEANOUT SCREW .....	5.00	ESP40	STIRRUP .....	5.00
ESP12	TANG SCREW .....	6.00	ESP41	STIRRUP PIN .....	3.00
ESP15	TOP BAND .....	10.00	ESP42	SEAR SPRING .....	12.00
ESP16	MIDDLE BAND, W/O Swivel .....	25.00	ESP43	SEAR SPRING SCREW .....	3.00
ESP17	LOWER BAND .....	12.00	ESP44	SEAR .....	20.00
ESP18	BAND SPRING .....	12.00	ESP45	SEAR SCREW .....	3.00
ESP20	FOREND CAP SCREW .....	5.00	ESP46	BRIDLE .....	14.00
ESP22	BUTTPLATE SCREWS, Pair .....	9.75	ESP47	BRIDLE SCREW .....	3.00
ESP27	TRIGGER .....	12.00	ESP7020	NIPPLE .....	5.00
ESP29	LOCK PLATE SCREW .....	6.00	ESPL61	M1861 LOCK ASSY, Complete ..	135.00
ESP31	SWIVEL .....	12.00	ESPL55	M1855 LOCK ASSY, Complete ..	155.00
ESP33	SLING SWIVEL SCREW .....	4.50			

## **NORTH-SOUTH SKIRMISH ASSOCIATION**

If you are one of the millions of Americans with an interest in Civil War or blackpowder shooting, the North-South Skirmish Association is for you. Ft. Shenandoah, the Association's home range, is located on several hundred acres of land in the rolling hills of the lower Shenandoah Valley just outside of Winchester, Va. The shooting competition in the N-SSA is done with live ammunition at both paper targets for individual score and at various breakable targets with 5 or 8 man team events. Matches are with musket, carbines, repeating rifles, revolvers, cannon and mortar. The N-SSA is comprised of regional divisions that host their own skirmishes. Twice a year, once in May and again in October, Ft. Shenandoah is host to the Association's National Skirmish. For further information visit [www.n-ssa.org](http://www.n-ssa.org)

## **UNCATALOGED ITEMS**

Please note we have listed only items that we have in sufficient quantity. We do have many "single" items and parts that are unlisted. All we ask is for a S.A.S.E. and on a separate sheet of paper a brief but specific request. We will respond to your request on items available, or will hold your request until we can supply it. All this is without obligation for you to purchase.

## **EUROARMS COLT**

EC01A	FRONT SIGHT – ARMY .....	4.00	EC23	TRIG. GUARD REAR SCREW .....	3.00
EC01N	FRONT SIGHT – NAVY .....	4.00	EC24	TRIG. GUARD FRONT SCREW .....	3.00
EC02	LOADING LEVER CATCH .....	6.50	EC25	TRIGGER .....	12.00
EC04	LOADING LEVER SCREW (Navy) .....	3.00	EC26	CYLINDER BOLT SCREW .....	3.00
EC05	BARREL WEDGE W/SPRING .....	16.00	EC27	CYLINDER BOLT .....	17.00
EC06	BARREL WEDGE SCREW .....	4.00	EC28	TRIGGER & CYL. STOP SPRING ..	4.50
EC07A	.44 CAL CYLINDER, Round .....	90.00	EC29	TRIGGER SPRING SCREW .....	3.00
EC07AF	.44 CAL CYLINDER, Fluted .....	115.00	EC30A	PLUNGER – ARMY .....	12.00
EC08	TRIGGER SCREW .....	3.00	EC30N	PLUNGER – NAVY .....	12.00
EC10A	CYLINDER PIN – ARMY .....	10.00	EC31	PLUNGER SCREW .....	3.00
EC13	HAND & SPRING .....	15.00	EC32A	LOADING LEVER – ARMY .....	30.00
EC14	HAMMER .....	27.00	EC32N	LOADING LEVER – NAVY .....	30.00
EC15	HAMMER SCREW .....	4.00	EC33	LOADING LEVER LATCH .....	4.00
EC16	BACKSTRAP SCREW .....	3.00	EC34	L/L LATCH SPRING .....	1.50
EC18A	BUTT SCREW - ARMY .....	3.00	EC35	L/L LATCH PIN .....	1.50
EC18N	BUTT SCREW – NAVY .....	3.00	EC36	HAMMER ROLLER PIN .....	1.50
EC19A	WOOD GRIPS Unfinished, Army ..	25.00	EC37	HAMMER ROLLER .....	2.00
EC20	HAMMER SPRING SCREW .....	3.00	ECLLA	L/L W/PLUNGER – ARMY .....	45.00
EC21	HAMMER SPRING .....	12.00	ECLLN	L/L W/PLUNGER – NAVY .....	45.00

## **EUROARMS REMINGTON**

7002	NIPPLE .....	2.25	RM18	CYLINDER BOLT SCREW .....	3.00
RM02	FRONT SIGHT .....	6.00	RM19	TRIGGER & BOLT SPRING .....	4.50
RM03	LOADING LEVER RETAINER .....	5.00	RM20	TRIGGER/BOLT SPRING SCREW ..	3.00
RM04	LOADING LEVER LATCH .....	7.00	RM21	TRIGGER GUARD BRASS .....	16.00
RM05	L/LEVER LATCH SPRING .....	3.00	RM22	TRIGGER .....	12.00
RM06	LOADING LEVER LATCH PIN ....	2.00	RM23	TRIGGER GUARD SCREW .....	3.00
RM07	LOADING LEVER .....	20.00	RM2426	GRIPS, Per Pair .....	22.00
RM08	LOADING LEVER SCREW .....	3.00	RM28	GRIP SCREW .....	3.00
RM09	LINK .....	3.00	RM30	HAMMER SPRING .....	12.00
RM10	LINK PIN .....	2.00	RM32	HAMMER .....	27.00
RM11	PLUNGER .....	10.00	RM33	HAMMER ROLLER .....	2.00
RM12	PLUNGER PIN .....	2.00	RM34	HAMMER ROLLER PIN .....	1.50
RM14	CYLINDER W/NIPPLES .44 .....	95.00	RM35	HAMMER SCREW .....	4.00
RM14A	CYLINDER W/NIPPLES .36 .....	95.00	RM36	HAND & SPRING .....	15.00
RM15	CYLINDER PIN .....	15.00	RM37	HAND PIVOT .....	3.00
RM17	CYLINDER BOLT .....	18.00	RMLL	L/L COMPLETE W/ RAMMER ....	55.00

## **EUROARMS ROGERS & SPENCER**

7002	NIPPLE .....	2.25	RS17	CYLINDER BOLT .....	24.00
RS02	FRONT SIGHT .....	4.00	RS18	CYL. BOLT / TRIGGER SCREW ....	3.00
RS03	BARREL CATCH .....	7.00	RS19	TRIGGER & BOLT SPRING .....	4.50
RS04	LOADING LEVER LATCH .....	5.00	RS20	TRIGGER/BOLT SPRING SCREW ..	3.00
RS05	LOADING LEVER SPRING .....	3.00	RS22	TRIGGER .....	12.00
RS06	LOADING LEVER LATCH PIN ....	2.00	RS23	REAR FRAME SCREW .....	3.00
RS07	LOADING LEVER, Complete .....	70.00	RS2426	GRIPS, Per Pair .....	35.00
RS08	CYLINDER PIN NUT .....	8.50	RS28	GRIP SCREW .....	3.00
RS09	CYLINDER PIN NUT SCREW .....	5.00	RS30	MAINSRING .....	12.00
RS10	PLUNGER SCREW .....	3.00	RS32	HAMMER .....	36.00
RS11	PLUNGER .....	10.00	RS33	HAMMER ROLLER .....	2.00
RS12	LOADING LEVER SCREW .....	3.00	RS34	HAMMER ROLLER PIN .....	1.50
RS14	CYLINDER W/NIPPLES .....	115.00	RS35	HAMMER SCREW .....	4.00
RS15	CYLINDER PIN .....	26.00	RS36	HAND & SPRING .....	15.00

**THE ABOVE LISTED PARTS FOR RODGERS & SPENCER, REMINGTON & COLT ARE EUROARMS FACTORY REPLACEMENT PARTS. MANY OF THESE PARTS CAN BE FITTED TO ORIGINALS.**

## **SHOOTERS SIGHT**

JA182	PISTOL FRONT SIGHT FOR COMPETITIVE SHOOTING, Fits Into Dovetail, .540" Tall x .090" wide. Fully Machined .....	18.00
-------	--	-------

**VISIT US ONLINE AT [WWW.SSFIREARMS.COM](http://WWW.SSFIREARMS.COM)**

Check our Website for Specials, New & Uncataloged Items.

# COLT SINGLE ACTION ARMY

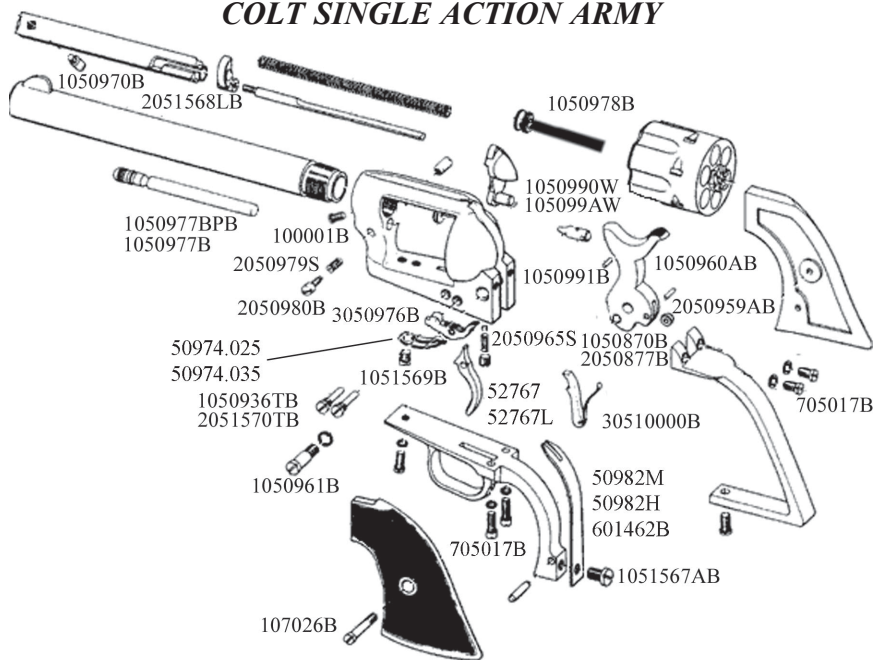

S&S Firearms is pleased to offer the finest in Model 1873 Colt Single Action Army Revolver parts for the discriminating Collector as well as the Cowboy action shooter and Firearms enthusiast. All parts proudly manufactured in the U.S.A. of the finest materials.

100001B	BASE PIN SCREW, BLACKPOWDER, 1ST GENERATION, BLUED .....	8.50
1050870B	HAMMER CAM, OVERSIZE, 1ST GENERATION .....	7.00
1050936TB	TRIGGER SCREW, 1ST GENERATION, BLUED .....	8.50
1050960AB	HAMMER ROLLER PIN, 1ST GENERATION .....	4.50
1050961B	HAMMER SCREW, 1ST GENERATION, BLUED .....	9.00
1050970B	EJECTOR TUBE SCREW, SHORT THREADS POST 1875, BLUED .....	9.00
1050977B	BASE PIN, SMOKELESS, 1ST, 2ND, 3RD GENERATION, BLUED .....	26.00
1050977BPB	BASE PIN, BLACKPOWDER, 1ST GENERATION, BLUED .....	26.00
1050978B	BASE PIN BUSHING, 1ST, 2ND GENERATION, REQUIRES FITTING, BLUED .....	16.00
1050990W	FIRING PIN, CONE SHAPE, 1ST GENERATION, IN THE WHITE .....	16.00
1050991B	FIRING PIN RIVET, 1ST GENERATION .....	5.00
105099AW	FIRING PIN, CONCAVE SHAPE, 1ST GENERATION, IN THE WHITE .....	17.00
1051567AB	MAINSRING SCREW, 1ST GENERATION, BLUED .....	8.00
1051569B	SEAR & BOLT SPRING SCREW, 1ST, 2ND, 3RD GENERATION, BLUED .....	8.00
107026B	STOCK SCREW, 1ST GENERATION, BLUED .....	8.00
2050877B	HAMMER CAM, STANDARD SIZE, 1ST GENERATION .....	6.50
2050959AB	HAMMER ROLLER, 1ST GENERATION .....	5.00
2050965S	GATE SPRING, 1ST GENERATION .....	6.00
2050979S	BASE PIN LATCH SPRING, 1ST GENERATION .....	4.00
2050980B	BASE PIN LATCH UNIT, 1ST GENERATION, BLUED .....	26.00
2051568LB	EJECTOR TUBE SCREWS, LONG THREADS 1873-1875, BLUED .....	9.00
2051570TB	TRIGGER SCREW, 2ND, 3RD GENERATION, BLUED .....	8.00
3050976B	BOLT, 1ST, 2ND, 3RD GENERATION MODELS .....	55.00
30510000B	HAND, 1ST, 2ND GENERATION .....	55.00
50974.025	SEAR & BOLT SPRING, Lightweight .....	7.50
50974.035	SEAR & BOLT SPRING, Medium .....	7.50
50982H	MAINSRING, Standard Tension, 10 lb .....	17.00
50982M	MAINSRING, Medium Tension, 8 lb .....	17.00
52767	TRIGGER, Machined, Blued .....	27.00
52767L	TRIGGER, Long, .020 Over Length, Blued .....	27.00

## ***COLT SINGLE ACTION ARMY***

601462B	MAINSRING, BISLEY MODEL .....	27.00
705011BPB	COMPLETE SCREW SET (14 PCS), BLACKPOWDER, 1ST GEN, BLUED .....	85.00
705013B	COMPLETE SCREW SET (13 PCS), SMOKELESS, 1ST GEN, BLUED .....	75.00
705015B	COMPLETE SCREW SET (13 PCS), SMOKELESS, 2ND, 3RD GEN, BLUED .....	77.00
705017B	STRAP & GUARD SET (6 PCS), 1ST, 2ND, 3RD GENERATION, BLUED .....	33.00

## ***COLT LIGHTNING***

CLR101	MAINSRING, SMALL, MEDIUM, LARGE FRAME (Reproduction) .....	49.00
CLR103	LOADING GATE SPRING, MEDIUM FRAME (Reproduction) .....	34.00
CLR104	EXTRACTOR, MED FRAME (Reproduction) .....	47.00
CLR106	MAGAZINE GATE SPRING (Reproduction) .....	35.00
CLR1732	32-20 EXTRACTOR, Machined, High Quality Reproduction .....	30.00
CLR1622	.22 RIMFIRE EXTRACTOR, Machined, High Quality Reproduction .....	25.00
CLR1738	38-40, 44-40 EXTRACTOR, Machined, High Quality Reproduction .....	30.00
CLR1122	MAINSRING (Reproduction) .....	30.00
GS171	BUTTSTOCK .....	60.00

## ***COLT REVOLVING RIFLE***

CRR9	HAMMER, Large Frame, (Reproduction) .....	48.00
CRR11	RIFLE/CARBINE REAR SIGHT, TWO LEAF MODEL, 100/300/500 YD WITH SCREWS ..	95.00
BKA257	BASIC COLT REVOLVING RIFLE SERVICE AND REPAIR Manual, See book section	

## ***WINCHESTER***

WN1	WINCHESTER M1885 HI-LOW WALL MAINSPRING (Repro) .....	43.00
WN2	WINCHESTER M1885 HI-LOW WALL SCHUETZEN HOOK BUTTPLATE (Repro) .....	49.00
WN3	WINCHESTER M1885 HI-LOW WALL SCHUETZEN LEVER, Standard Scroll (Repro) .....	65.00
WN4	WINCHESTER M1885 HI-LOW WALL SCHUETZEN LEVER, Fancy Scroll (Repro) .....	65.00
WN5	WINCHESTER M1885 HI-LOW WALL FIRING PIN, Blackpowder (Repro) .....	45.00
WN6	WINCHESTER M1885 HI-LOW WALL FIRING PIN, Smokeless (Repro) .....	45.00
	<b>Winchester Model 61</b>	
	P1033 MAINSPRING SCREW .....	3.50
P1005	SLIDE HANDLE SCREW .....	3.50
	<b>Winchester Model 62</b>	
	P1034 MAINSPRING TENSION SCREW .....	3.50
	P1035 SPRING COVER SCREW .....	3.50
P1006	SLIDE HANDLE SCREW .....	3.50
	<b>Winchester Model 86</b>	
	P1036 TANG SCREW .....	4.50
	P1037 TANG SCREW, For Tang Sight .....	4.50
P1011	CARRIER STOP SCREW .....	3.50
	P1038 UPPER TANG PLUG SCREW .....	3.50
P1012	CARTRIDGE GUIDE SCREW .....	3.50
	<b>Winchester Model 94</b>	
P1013	CARTRIDGE STOP SCREW .....	3.50
	P1039 CARRIER SCREW .....	3.50
P1014	HAMMER SCREW .....	5.00
	P1040 CARRIER SPRING SCREW .....	3.50
P1015	MAINSRING TENSION SCREW .....	3.50
	P1041 CARTRIDGE GUIDE SCREW .....	3.50
P1016	SEAR/TRIG SPRING SCREW .....	3.50
	P1042 LEVER LINK SCREW .....	3.50
P1017	SPRING COVER SCREW .....	3.50
	P1043 LEVER PIN STOP SCREW .....	3.50
P1018	TANG SCREW .....	4.50
	P1044 FOREARM TIP TENON SCREW .....	3.50
P1019	FOREARM TIP TENON SCREW .....	3.50
	P1045 FRONT BAND SCREW .....	3.50
	P1046 FRONT TANG SIGHT SCREW .....	3.50
P1020	SLIDE HANDLE SCREW .....	3.50
	P1047 HAMMER SCREW .....	5.00
P1021	FIRING PIN STOP SCREW .....	3.50
	P1048 LINK PIN STOP SCREW .....	3.50
P1022	MAINSRING SCREW .....	3.50
	P1049 MAGAZINE PLUG SCREW .....	3.50
P1023	MAINSRING TENSION SCREW .....	3.50
	P1050 MAINSPRING SCREW .....	3.50
P1024	SLIDE COVER STOP SCREW .....	3.50
	P1051 MAINSPRING STRAIN SCREW .....	3.50
P1025	TANG SCREW .....	4.50
	P1052 REAR BAND SCREW .....	3.50
P1026	TANG SCREW, For Tang Sight .....	4.50
	P1053 SEAR/SAFETY SPRING SCREW .....	3.50
P1026A	CARRIER SPRING SCREW .....	3.50
	P1054 SPRING COVER SCREW .....	3.50
P1027	UPPER TANG PLUG SCREW .....	3.50
	P1055 TANG SCREW .....	4.50
	P1056 TANG SCREW, For Tang Sight .....	4.50
	P1057 UPPER TANG PLUG SCREW .....	3.50
	<b>Winchester Model 92</b>	
	P1058 MAGAZINE BAND SCREW .....	3.50
P1028	CARRIER SCREW .....	3.50
	P1058A MAGAZINE PLUG SCREW .....	3.50
P1029	CARTRIDGE GUIDE SCREW .....	3.50
P1030	FRONT TANG SIGHT SCREW .....	3.50
P1031	HAMMER SCREW .....	5.00
P1032	LOCK BOLT PIN STOP SCREW .....	3.50

The Above Screws Are Reproduction

***VISIT US ONLINE AT [WWW.SSFIREARMS.COM](http://WWW.SSFIREARMS.COM)***

Check our Website for Specials, New & Uncataloged Items.

# HENRY RIFLE

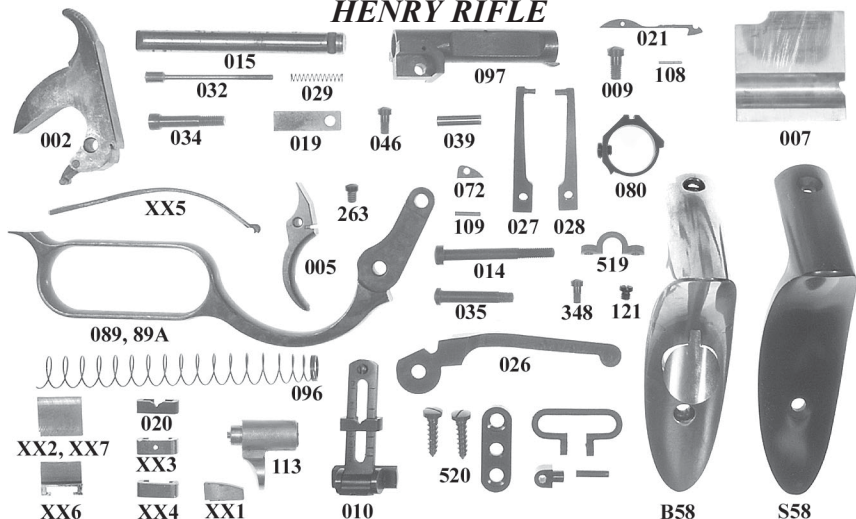

HRAXX1	FRONT SIGHT, Standard Height .....	16.00
HRAXX2	FRONT SIGHT, Competition Height, .082" Wide .....	17.00
HRAXX3	REAR SIGHT SLIDE, With Drilled Peephole.....	22.00
HRAXX4	REAR SIGHT SLIDE, w/o Peephole or Notch .....	20.00
HRAXX5	MAINSRING .....	18.00
HRAXX6	"L" SHAPED SLIDE, Replaces Factory Slide & Provides Two Peep Positions .....	25.00
HRAXX7	BRASS FRONT SIGHT BLASDE, Competition Height, .090" Wide .....	17.00
HRA002	HAMMER .....	67.00
HRA005	TRIGGER .....	28.00
HRA007	CARRIER BLOCK .....	46.00
HRA009	MAINSRING SCREW .....	5.00
HRA010	REAR SIGHT .....	70.00
HRA014	TANG SCREW .....	7.00
HRA015	FIRING PIN EXTENSION .....	18.00
HRA019	TRIGGER SPRING .....	8.00
HRA020	REAR SIGHT SLIDE .....	20.00
HRA021	EXTRACTOR 44/40 .....	27.00
HRA026	LIFTER ARM .....	35.00
HRA027	RIGHT HAND LEVER SPRING .....	21.00
HRA028	LEFT HAND LEVER SPRING .....	21.00
HRA029	FIRING PIN SPRING .....	6.00
HRA032	FIRING PIN .....	18.00
HRA034	HAMMER SCREW .....	6.00
HRA035	LEVER SCREW .....	6.00
HRA039	LEVER PIN .....	5.00
HRA046	LEVER SPRING SCREW .....	6.00
HRA072	CAM LEVER .....	15.00
HRA080	FRONT BAND, Octagon .....	42.50
HRA089	LEVER, IRON FRAME, Also fits 1866 & 1873 Winchester. With Locking Spur .....	82.00
HRA089A	LEVER, BRASS FRAME .....	82.00
HRA096	MAGAZINE COIL SPRING .....	12.00
HRA097	BREECH BLOCK .....	85.00
HRA108	EXTRACTOR PIN .....	5.00
HRA109	CAM LEVER PIN .....	5.00
HRA113	CARTRIDGE FOLLOWER, Brass .....	25.00
HRA121	BAND SCREW (Reproduction) .....	5.00
HRA263	TRIGGER SPRING SCREW .....	5.00
HRA348	FRONT SWIVEL SCREW .....	5.00
HRA519	FRONT SWIVEL .....	25.00
HRA520	COMPLETE SWIVEL ASSEMBLY, BUTTSTOCK .....	62.00
HRA558	BUTTPLATE, STEEL .....	62.00
HRA558	BUTTPLATE, BRASS, COMPLETE WITH TRAP .....	85.00

The Above Parts are manufactured to fit all reproduction Henry Rifles

# BURNSIDE

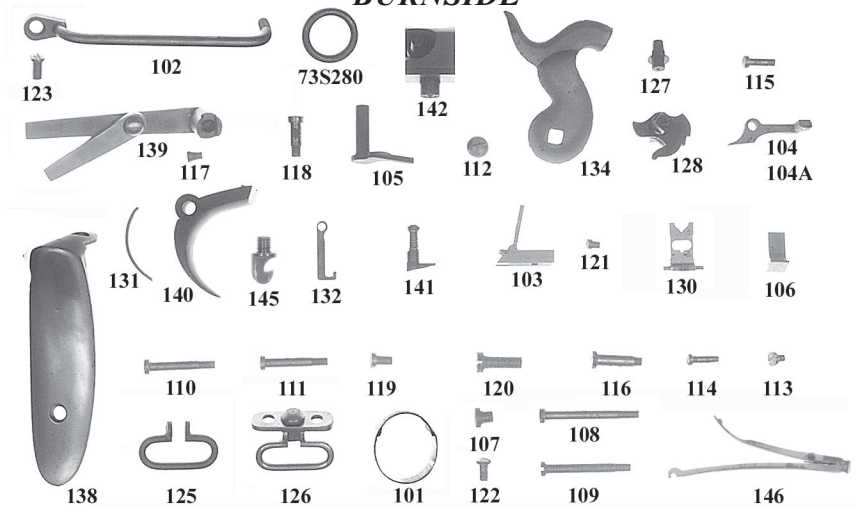

BN101	BARREL BAND, Carbine .....	35.00
BN102	SADDLE BAR WITH SCREW .....	57.00
BN103	REAR SIGHT, Complete, with mounting screw .....	80.00
BN104	SEAR .....	32.00
BN104A	SEAR, Machined .....	38.00
BN105	LEVER PIN (Hinge) .....	35.00
BN106	FRONT SIGHT, High .....	15.00
BN107	TOP STRAP SCREW .....	5.00
BN108	FRONT TANG SCREW .....	8.00
BN109	REAR TANG SCREW .....	8.00
BN110	FRONT LOCKPLATE SCREW .....	8.00
BN111	REAR LOCKPLATE SCREW .....	8.00
BN112	HAMMER SCREW .....	7.00
BN113	MAINSRING SCREW .....	4.00
BN114	BRIDLE SCREW .....	4.00
BN115	SEAR SCREW .....	4.00
BN116	HINGE TO BLOCK SCREW .....	5.00
BN117	BREECH BLOCK PIVOT SCREW, Threads into side of frame .....	7.00
BN118	FINGER LEVER SCREW .....	5.00
BN119	LEVER TO BLOCK SCREW, Front, Small .....	4.00
BN120	LEVER TO BLOCK SCREW, Rear, Large .....	4.00
BN121	REAR SIGHT BASE SCREW .....	4.00
BN122	FOREND SCREW .....	4.00
BN123	SADDLE BAR SCREW .....	4.00
BN125	BUTT SLING SWIVEL, without base .....	10.00
BN126	REAR SWIVEL ASSEMBLY, Base and Rotating Swivel .....	42.00
BN127	NIPPLE .....	8.00
BN128	TUMBLER, Complete .....	52.00
BN130	REAR SIGHT LADDER, With Pin .....	45.00
BN131	FINGER LEVER SPRING .....	32.00
BN132	TRIGGER SPRING .....	32.00
BN134	HAMMER .....	45.00
BN138	BUTTPLATE .....	40.00
BN139	COMBO TOOL, Nipple Wrench, 2 Screwdrivers, Exact copy of Original .....	35.00
BN140	FINGER LEVER .....	62.00
BN141	BREECHBLOCK LOCKING TOGGLE, With Spring .....	48.00
BN142	REAR BREECHBLOCK WITH NIPPLE .....	90.00
BN145	LEVER CATCH .....	48.00
BN146	MAINSRING, Cast Steel, Requires minor fitting. Tempered .....	45.00
GS134	BUTTSTOCK .....	65.00
GS135	FOREND .....	40.00
73S280	SADDLE BAR RING .....	5.00

All Above Parts & Stocks are Reproduction Unless Otherwise Noted

## BALLARD

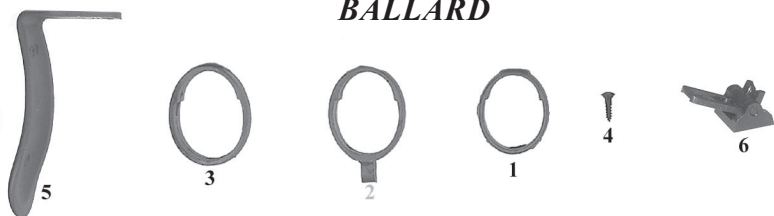

BD1	RIFLE TOP BAND (Reproduction) .....	32.00
BD2	RIFLE MIDDLE BAND (Reproduction) .....	35.00
BD3	RIFLE LOWER BAND (Reproduction) .....	32.00
BD4	RIFLE BAND WOOD SCREW (Reproduction) .....	2.00
BD5	BUTTPLATE (Reproduction) .....	35.00
BD6	REAR SIGHT (Reproduction) .....	70.00
GS127	C.W. BALLARD BUTTSTOCK, With Top & Lower Tang Inletting. 11 1/4" OAL, Repro .....	65.00
GS127A	BROWN OR MERRIMACK BALLARD BUTTSTOCK, 11" OAL (Reproduction) .....	65.00
GS127B	BALLARD BUTTSTOCK, Postwar, 12" OAL (Reproduction) .....	65.00
GS128	RIFLE FOREND, 3 Band (Reproduction) .....	50.00
GS128A	CARBINE FOREND (Reproduction) .....	42.00

## GALLAGHER

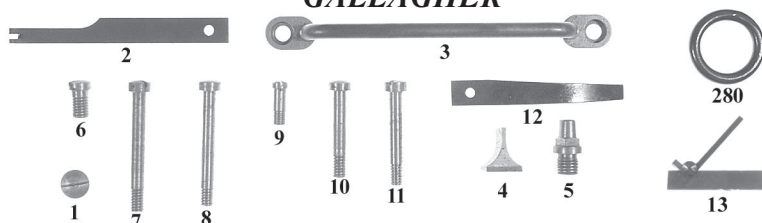

GC1	HAMMER SCREW (Reproduction) .....	7.00
GC2	MAINSRING (Reproduction) .....	37.00
GC3	SADDLE BAR (Reproduction) .....	57.00
GC4	FRONT SIGHT, Extra high (Reproduction) .....	15.00
GC5	NIPPLE (Reproduction) .....	8.00
GC6	FRONT TOP STRAP TO RECEIVER SCREW (Reproduction) .....	4.00
GC7	MIDDLE TOP STRAP SCREW (Reproduction) .....	8.00
GC8	REAR TOP STRAP SCREW (Reproduction) .....	8.00
GC9	BRIDLE SCREW (Reproduction) .....	4.00
GC10	FRONT LOCKPLATE SCREW (Reproduction) .....	8.00
GC11	REAR LOCKPLATE SCREW (Reproduction) .....	8.00
GC12	SEAR SPRING (Reproduction) .....	22.00
GC13	REAR SIGHT, Complete with mounting screw (Reproduction) .....	70.00
GS136	BUTTSTOCK (Reproduction) .....	60.00
73S280	SADDLE BAR RING (Reproduction) .....	5.00

## MERRILL

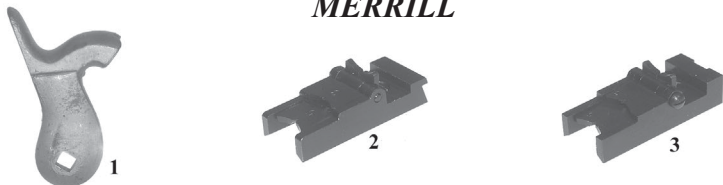

MER1	HAMMER (Reproduction) .....	42.00
MER2	REAR SIGHT, 1 <sup>st</sup> Model (Reproduction) .....	80.00
MER3	REAR SIGHT, 2 <sup>nd</sup> Model (Reproduction) .....	80.00
GS172	STOCK, 1 <sup>st</sup> Model, With Patchbox Inlet (Reproduction) .....	175.00
GS172A	STOCK, 2 <sup>nd</sup> Model, Without Patchbox Inlet (Reproduction) .....	175.00

**VISIT US ONLINE AT [WWW.SSFIREARMS.COM](http://WWW.SSFIREARMS.COM)**

Check our Website for Specials, New & Uncataloged Items.



# MAYNARD

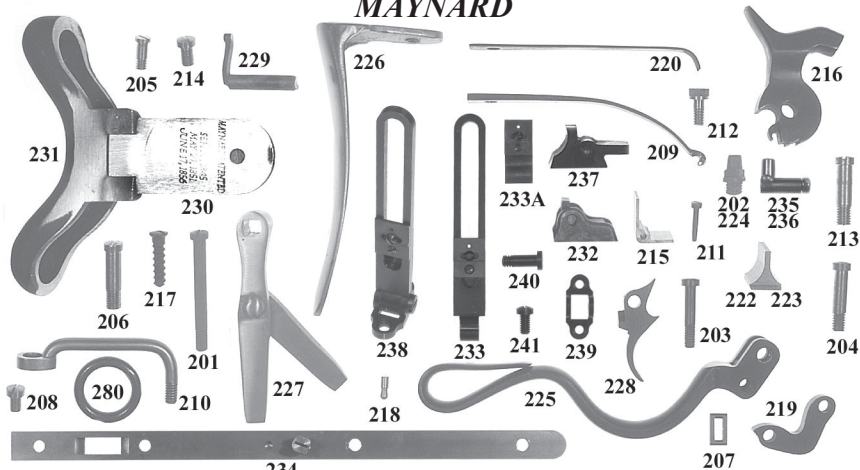

MY201	TANG SCREW, Original	22.00
MY202	NIPPLE (Reproduction)	8.00
MY203	TRIGGER SCREW (Reproduction)	4.00
MY204	LEVER SCREW (Reproduction)	4.00
MY205	LINK SCREW, 2 Required (Reproduction)	4.00
MY206	HINGE SCREW (Reproduction)	5.00
MY207	TUMBLER STIRRUP (Reproduction)	8.00
MY208	SADDLE BAR SCREW (Reproduction)	4.00
MY209	MAINSRING (Reproduction)	35.00
MY210	SADDLE BAR (Reproduction)	50.00
MY211	REAR SIGHT PIVOT SCREW (Reproduction)	5.00
MY212	MAINSRING SCREW (Reproduction)	12.00
MY213	HAMMER SCREW (Reproduction)	5.00
MY214	TRIGGER BAR TO FRAME SCREW, 2 Required (Reproduction)	4.00
MY215	REAR SIGHT LEAF, L Shaped (Reproduction)	15.00
MY216	HAMMER (Reproduction)	38.00
MY217	TRIGGER PLATE WOOD SCREW (Reproduction)	4.00
MY218	LEVER CATCH PIN (Reproduction)	5.00
MY219	LEVER LINK (Reproduction)	35.00
MY220	TRIGGER SPRING (Reproduction)	25.00
MY222	FRONT SIGHT, EXTRA HIGH, .100 WIDE	16.00
MY223	FRONT SIGHT, EXTRA HIGH, .050 WIDE	16.00
MY224	NIPPLE, 2ND MODEL, ORIGINAL	32.00
MY225	LEVER, Polished and Blued (Reproduction)	65.00
MY226	BUTTPLATE (Reproduction)	40.00
MY227	COMBO TOOL, Nipple Wrench, 2 Screwdrivers, Exact copy of Original	35.00
MY228	TRIGGER (Reproduction)	32.00
MY229	1 <sup>ST</sup> MODEL TAKEDOWN PIN, Requires minimum fitting	50.00
MY230	1 <sup>ST</sup> MODEL PATCHBOX DOOR, Requires minimum fitting	80.00
MY231	1 <sup>ST</sup> MODEL BUTTPLATE WITH PATCHBOX DOOR	198.00
MY232	REAR SIGHT, Complete (Reproduction)	70.00
MY233	1 <sup>ST</sup> MODEL REAR SIGHT, Fully machined, High Quality (Reproduction)	90.00
MY233A	SIGHT SLIDE FOR TANG SIGHT, Fits all Tang Sights Except Gear Driven (Repro)	50.00
MY234	2 <sup>ND</sup> MODEL TRIGGERPLATE, Complete w/ Mainspring Screw & Lever Catch Pin (Repro)	95.00
MY235	1 <sup>ST</sup> MODEL NIPPLE, Uses Pistol Caps (Reproduction)	25.00
MY236	1 <sup>ST</sup> MODEL NIPPLE, Uses Standard Musket Caps (Reproduction)	25.00
MY237	SPORTER MODEL REAR SIGHT, Fits Dovetail in Barrel (Reproduction)	80.00
MY238	1873/1882 TANG SIGHT, With Base & Screws (Reproduction)	130.00
MY239	1873-1882 TANG SIGHT BASE	40.00
MY240	CROSS SCREW FOR TANG SIGHT TO BASE, Fits 1 <sup>ST</sup> Model thru 1882 (Reproduction)	8.00
MY241	1873-1882 SIGHT BASE SCREW, 2 Required	4.00
GS125	1 <sup>ST</sup> MODEL MAYNARD BUTTSTOCK (Reproduction)	75.00
GS126	2 <sup>ND</sup> MODEL MAYNARD BUTTSTOCK (Reproduction)	65.00
GS126A	1882 FOREND, #16 Model, can be used on others (Reproduction)	40.00
73S280	SADDLE BAR RING (Reproduction)	5.00

# SHARPS

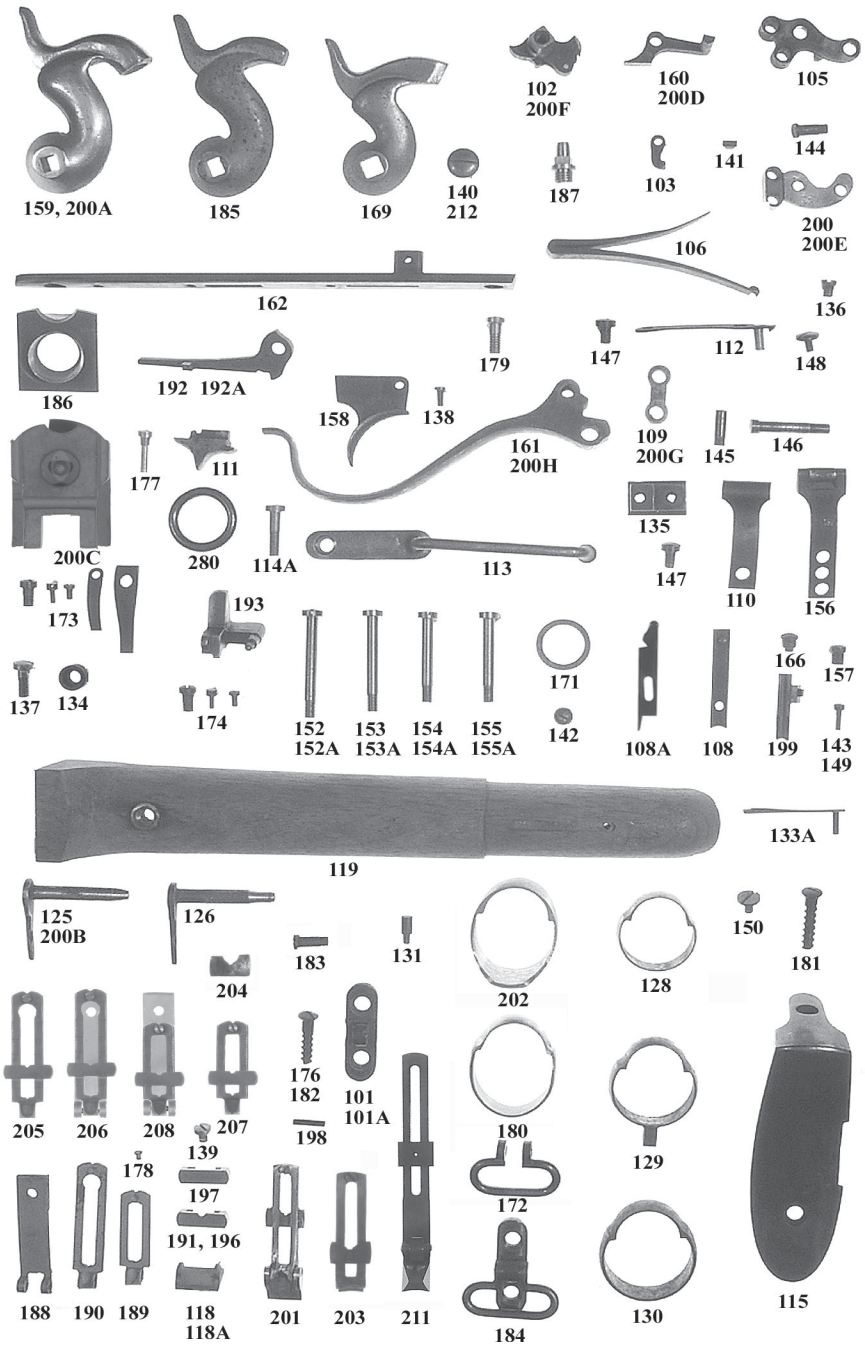

# SHARPS

SH101	REAR SWIVEL BASE .....	30.00
SH101A	REAR SWIVEL BASE (Reproduction) .....	20.00
SH102	TUMBLER, Complete .....	80.00
SH103	TUMBLER STIRRUP .....	6.00
SH105	BRIDLE .....	17.00
SH106	MAINSRING .....	60.00
SH108	PELLET FEED COVER .....	30.00
SH108A	PELLER FEED CUTOFF (Reproduction) .....	27.50
SH109	TOGGLE, Block to lever .....	18.00
SH110	LEVER SPRING .....	52.00
SH111	LEVER CATCH .....	45.00
SH112	LEVER CATCH SPRING .....	30.00
SH113	SWIVEL BAR, Carbine .....	42.00
SH114A	SWIVEL BAR SCREW (Reproduction) .....	5.00
SH115	BUTT PLATE, Rifle, Cut For Patch Box .....	65.00
SH118	REAR SIGHT BASE GUARD .....	22.00
SH118A	REAR SIGHT BASE GUARD (Reproduction) .....	10.00
GS117	BUTTSTOCK, CARBINE, SLANT BREECH With Patchbox Inlet (Reproduction) .....	115.00
GS118	BUTTSTOCK, CARBINE, SLANT BREECH Without Patchbox Inlet (Reproduction) .....	115.00
GS119	FOREND, CARBINE, SLANT BREECH (Reproduction) .....	65.00
GS120	BUTTSTOCK, CARBINE, M1859 With Patchbox Inlet (Reproduction) .....	110.00
GS121	BUTTSTOCK, CARBINE, M1863 Without Patchbox Inlet (Reproduction) .....	110.00
GS122	BUTTSTOCK, RIFLE M1859/1863 With Patchbox Inlet (Reproduction) .....	110.00
GS123	FOREND, CARBINE M1859/1863 (Reproduction) .....	40.00
GS124	FOREND, Rifle, 3 Band (Reproduction) .....	85.00
GS124A	FOREND, Rifle, 3 Band 36" Barrel (Reproduction) .....	85.00
GS140	BUTTSTOCK, RIFLE M1874 Without Patchbox Inlet (Reproduction) .....	110.00
GS141	BUTTSTOCK, RIFLE M1874 With Patchbox and Double Set Trigger Inlet (Repro) .....	125.00
SH125	HINGE PIN, Percussion .....	25.00
SH126	HINGE PIN, Cartridge .....	40.00
SH128	UPPER BAND, Rifle .....	35.00
SH129	MIDDLE BAND, Rifle, Without Swivel And Screw .....	55.00
SH130	LOWER BAND, Rifle .....	40.00
SH131	HINGE PIN CATCH .....	7.00
SH133A	BAND SPRING (Reproduction) .....	10.00
SH134	FOREND SCREW WASHER .....	3.00
SH135	BARREL BLOCK .....	15.00
SH136	MAINSRING SCREW .....	3.00
SH137	FOREND SCREW (Reproduction) .....	6.00
SH138	TRIGGER SCREW .....	3.00
SH139	REAR SIGHT BASE SCREW (Reproduction) .....	5.00
SH140	HAMMER SCREW .....	10.00
SH141	TUMBLER STIRRUP SCREW .....	3.00
SH142	LAWRENCE PRIMER TOP SCREW (Cover Spring) .....	18.00
SH143	LAWRENCE PRIMER SIDE SCREW (Pellet Cutoff) .....	15.00
SH144	BRIDLE SCREW .....	3.00
SH145	TOGGLE TO LEVER SCREW .....	6.00
SH146	TOGGLE TO BLOCK SCREW (Reproduction) .....	14.00
SH147	LEVER SPRING SCREW .....	3.00
SH148	LEVER CATCH SCREW .....	3.00
SH149	FIRING PIN SCREW .....	15.00
SH150	NOSE CAP SCREW .....	3.00
SH151	HINGE PIN CATCH SCREW .....	3.00
SH152	FRONT TANG SCREW .....	15.00
SH152A	FRONT TANG SCREW (Reproduction) .....	7.00
SH153	REAR TANG SCREW .....	15.00
SH153A	REAR TANG SCREW (Reproduction) .....	7.00
SH154	FRONT LOCKPLATE SCREW .....	15.00
SH154A	FRONT LOCKPLATE SCREW (Reproduction) .....	7.00
SH155	REAR LOCKPLATE SCREW .....	15.00
SH155A	REAR LOCKPLATE SCREW (Reproduction) .....	7.00
SH156	SPRINGFIELD SHARPS ROLLER LEVER SPRING .....	65.00
SH157	LEVER CATCH SPRING SCREW .....	4.00
SH158	TRIGGER .....	20.00
SH159	HAMMER, Percussion, M1863 (Reproduction) .....	38.00
SH160	SEAR .....	40.00

## ***SHARPS***

SH161	LEVER, Percussion .....	125.00
SH162	TRIGGER BAR .....	40.00
SH165	LAWRENCE PRIMER PELLETT FOLLOWER .....	35.00
SH166	LAWRENCE PRIMER BOTTOM SCREW .....	25.00
SH169	HAMMER, Cartridge, M1874 (Reproduction) .....	38.00
SH170	PATCH BOX SPRING SCREW .....	3.00
SH171	CONANT BREECH BLOCK GAS SEAL, Slant Breech .....	45.00
SH172	SLING SWIVEL, Front Or Rear (Reproduction) .....	15.00
SH173	SHARPS SET TRIGGER SPRING & SCREW SET. One each large and small flat springs, 3 screws. All necessary components for set trigger plate .....	80.00
SH174	SHARPS SET TRIGGER SCREW SET. 2 screws for springs and 1 adjusting set screw .....	25.00
SH176	SLING SWIVEL BASE WOOD SCREW .....	8.00
SH177	BREECH BLOCK CLEAN OUT SCREW (Reproduction) .....	8.00
SH178	REAR SIGHT ELEVATION BAR RETAINING SCREW (Reproduction) .....	4.00
SH179	FRONT TRIGGER BAR SCREW (Reproduction) .....	4.00
SH180	CARBINE BAND (Reproduction) .....	35.00
SH181	BUTT PLATE WOOD SCREW .....	8.00
SH182	TRIGGER GUARD WOOD SCREW .....	8.00
SH183	SLING SWIVEL PIVOT SCREW, Front and Rear .....	3.00
SH184	REAR SWIVEL ASSEMBLY, Complete with Swivel, Base, Pivot Screw (Reproduction) .....	35.00
SH185	HAMMER, Cartridge Conversion (Reproduction) .....	38.00
SH186	BREECH BLOCK FACE PLATE (Gas Seal) M1859-1863 (Reproduction) .....	87.00
SH187	NIPPLE (Reproduction) .....	7.00
SH188	REAR SIGHT BASE (Reproduction) .....	32.00
SH189	REAR SIGHT LADDER, CARBINE (Reproduction) .....	32.00
SH190	REAR SIGHT LADDER, RIFLE (Reproduction) .....	32.00
SH191	REAR SIGHT ELEVATION BAR (Reproduction) .....	18.00
SH192	EXTRACTOR, Cartridge Model 50/70, CAST (Reproduction) .....	40.00
SH192A	EXTRACTOR, Cartridge Model 50/70, MACHINED (Reproduction) .....	75.00
SH193	FIRING PIN, Cartridge, Centerfire 50/70 (Reproduction) .....	35.00
SH196	REAR SIGHT ELEVATION BAR, Machined Steel, "V" Notch .....	20.00
SH197	REAR SIGHT ELEVATION BAR, Machined Steel, No "V" Notch, Peep Use .....	20.00
SH198	REAR SIGHT JOINT PIN .....	6.00
SH199	LAWRENCE PRIMER PELLETT FEEDER (Reproduction) .....	27.50
SH200	SLANT BREECH M1853 BRIDLE, Original .....	45.00
SH200A	SLANT BREECH M1853 HAMMER (Reproduction) .....	40.00
SH200B	SLANT BREECH M1853 HINGE PIN, Casting (Reproduction) .....	40.00
SH200C	SLANT BREECH M1853 BREECH BLOCK, Casting, Needs Machining (Reproduction) .....	85.00
SH200D	SLANT BREECH M1853 SEAR, Casting (Reproduction) .....	35.00
SH200E	SLANT BREECH M1853 BRIDLE, Casting (Reproduction) .....	25.00
SH200F	SLANT BREECH M1853 TUMBLER, Casting (Reproduction) .....	40.00
SH200G	SLANT BREECH M1853 BREECH BLOCK TO LEVER LINK, Casting (Reproduction) .....	25.00
SH200H	SLANT BREECH M1853 BREECH LEVER, Casting (Reproduction) .....	46.00
SH201	SLANT BREECH M1853 REAR SIGHT (Reproduction) .....	125.00
SH202	SLANT BREECH M1853 BAND, BRASS (Reproduction) .....	48.00
SH203	SLANT BREECH SHARPS REAR SIGHT LADDER, Slide, Stop Screw (Reproduction) .....	75.00
SH204	SLANT BREECH SHARPS REAR SIGHT SLIDE (Reproduction) .....	45.00
SH205	RIFLE REAR SIGHT LADDER & SLIDE, Machined (Reproduction) .....	70.00
SH206	RIFLE REAR SIGHT BASE, LADDER & SLIDE, Machined (Reproduction) .....	125.00
SH207	CARBINE REAR SIGHT LADDER & SLIDE, Machined (Reproduction) .....	70.00
SH208	CARBINE REAR SIGHT BASE, LADDER & SLIDE, Machined (Reproduction) .....	125.00
SH210	M1870 SPRINGFIELD ALTERATION 2 BAND RIFLE RAMROD (Reproduction) .....	50.00
SH211	SLANT BREECH SHARPS SPORTING RIFLE TANG SIGHT, w/ Base & Screw (Repro) ...	135.00
SH212	SLANT BREECH SHARPS HAMMER SCREW (Reproduction) .....	10.00
73S280	SWIVEL BAR RING, Carbine (Reproduction) .....	5.00

## ***NATIONAL RIFLE ASSOCIATION***

Since 1871 the NRA has worked to educate hunters, reform restrictive gun laws, and strengthen the criminal justice system. The NRA also promotes the effective wildlife management and conservation policies. Along with sanctioning about 12,000 shooting tournaments each year they also help run the National Matches at Camp Perry. Please consider joining this worthwhile organization, Their member benefits are too numerous to list here. Ask for a membership application and we will gladly provide it with your order or call the NRA toll fee at 1-800-NRA 3888.

## SHARPS AND HANKINS

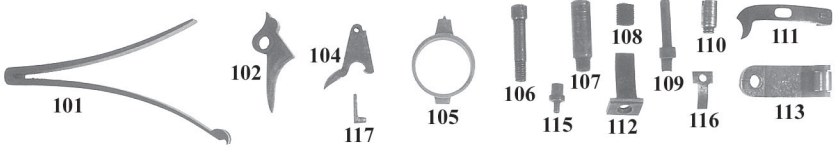

HA101	MAINSRING .....	68.00
HA102	TRIGGER .....	20.00
HA104	LEVER CATCH .....	47.00
HA105	FRONT SIGHT, Mounted on barrel ring .....	115.00
HA106	FRAME SCREW .....	12.00
HA107	LEVER PIVOT SCREW .....	25.00
HA108	EXTRACTOR RETAINING SCREW .....	14.00
HA109	EXTRACTOR .....	25.00
HA110	LEVER/LINK PIVOT SCREW .....	25.00
HA111	SAFETY SLIDE .....	35.00
HA112	TRIGGER SPRING .....	27.00
HA113	BARREL ROLLER, With Spring Mount .....	48.00
HA115	FIRING PIN .....	25.00
HA116	LEVER CATCH SPRING .....	25.00
HA117	TUMBLER FLY .....	15.00
GS170	BUTTSTOCK .....	60.00

## STARR CARBINE

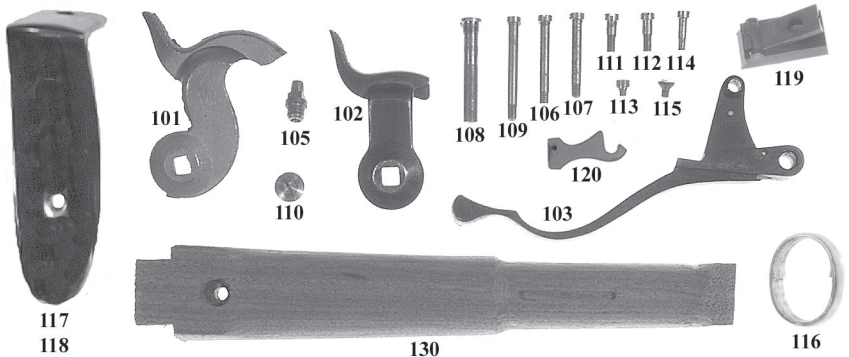

ST101	HAMMER, PERCUSSION (Reproduction) .....	38.00
ST102	HAMMER, CARTRIDGE (Original) .....	65.00
ST103	LEVER, Stripped (Original) .....	85.00
ST105	NIPPLE (Reproduction) .....	7.00
ST106	FRONT LOCKPLATE SCREW (Reproduction) .....	7.00
ST107	REAR LOCKPLATE SCREW (Reproduction) .....	7.00
ST108	HINGE SCREW (Reproduction) .....	12.00
ST109	TANG SCREW (Reproduction) .....	7.00
ST110	HAMMER SCREW (Reproduction) .....	7.00
ST111	FOREND SCREW (Reproduction) .....	3.00
ST112	TRIGGER PLATE SCREW (Reproduction) .....	3.00
ST113	REAR SIGHT SCREW (Reproduction) .....	3.00
ST114	BRIDLE SCREW (Reproduction) .....	3.00
ST115	MAINSRING SCREW (Reproduction) .....	4.00
ST116	BARREL BAND, Brass (Reproduction) .....	45.00
ST117	BUTTPLATE, Brass (Reproduction) .....	45.00
ST118	BUTTPLATE, Steel (Original) .....	80.00
ST119	REAR SIGHT, Complete with mounting screw (Reproduction) .....	70.00
ST120	LEVER CATCH, Required minimum fitting (Reproduction) .....	25.00
GS129	BUTTSTOCK (Reproduction) .....	60.00
GS130	FORESTOCK (Reproduction) .....	40.00

# SMITH

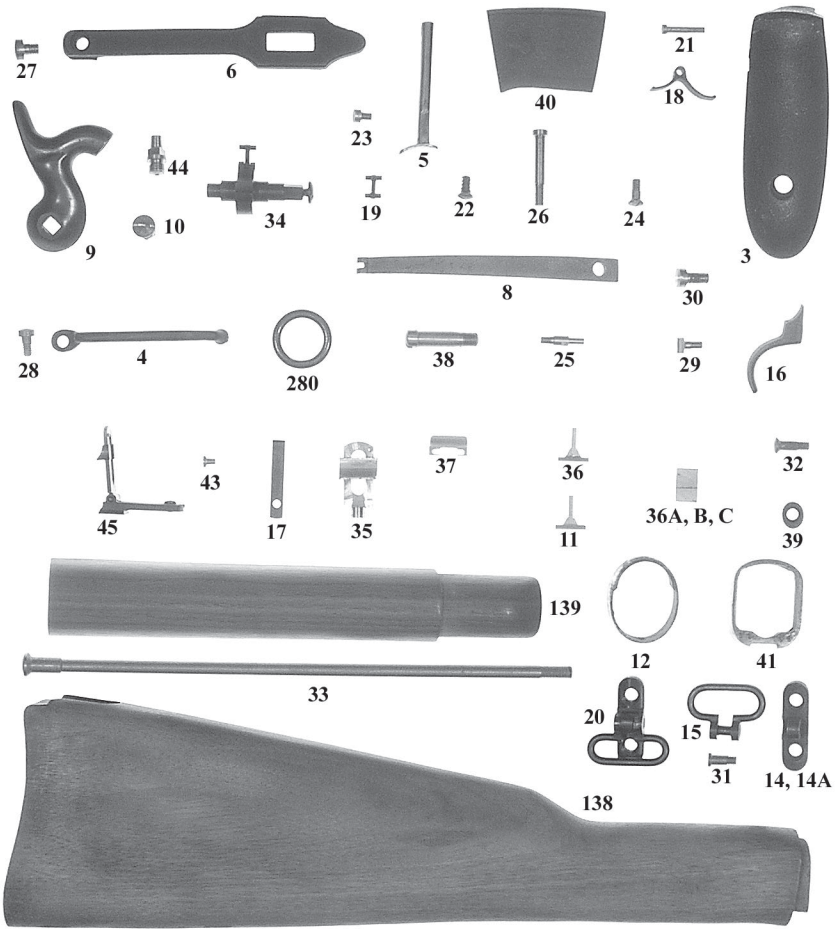

GS138	BUTTSTOCK .....	110.00
GS139	FOREND .....	42.00
SC3	BUTTPLATE .....	40.00
SC4	SADDLE BAR .....	55.00
SC5	FINGER LEVER .....	20.00
SC6	TOP STRAP .....	22.00
SC8	MAINSRING .....	32.00
SC9	HAMMER .....	38.00
SC10	HAMMER SCREW .....	7.00
SC11	FRONT SIGHT, One piece, extra high, fits dovetail .....	20.00
SC12	BARREL BAND .....	35.00
SC14	BUTT SWIVEL BASE, Original .....	30.00
SC14A	BUTT SWIVEL BASE, Repro .....	20.00
SC15	BUTT AND BAND SWIVEL .....	15.00
SC16	TRIGGER .....	18.00
SC17	REAR SIGHT SPRING .....	8.00
SC18	TRIGGER SPRING .....	27.00
SC19	TUMBLER STIRRUP .....	8.00
SC20	BUTT SWIVEL ASSEMBLY, Complete .....	35.00

## SMITH

SC21	TRIGGER SCREW .....	4.00
SC22	TRIGGER GUARD SCREW, Wood, rear position .....	4.00
SC23	CLEAN OUT SCREW .....	4.00
SC24	TRIGGER BOW SCREW, Machine .....	4.00
SC25	AXLE PIN .....	6.00
SC26	SIDEPLATE SCREW .....	7.00
SC27	TOP STRAP SCREW .....	5.00
SC28	SADDLE BAR SCREW .....	4.00
SC29	FRAME BOLT .....	5.00
SC30	MAINSRING SCREW .....	5.00
SC31	BUTT AND BAND SWIVEL SCREW .....	3.00
SC32	FOREND SCREW .....	4.00
SC33	BUTTSTOCK SCREW (Buttstock To Frame) .....	27.00
SC34	TUMBLER, Complete with stirrup and hammer screw .....	52.00
SC35	REAR SIGHT LADDER AND SLIDE, Competition style .....	47.00
SC36	FRONT SIGHT, Complete, Base And Blade Original Style, 2 Piece .....	23.00
SC36A	FRONT SIGHT BLADE, .094 Thick .....	6.50
SC36B	FRONT SIGHT BLADE, .075 Thick .....	6.50
SC36C	FRONT SIGHT BLADE, .062 Thick .....	6.50
SC37	REAR SIGHT ELEVATION BAR, Competition .....	23.00
SC38	HINGE SCREW .....	9.00
SC39	FORESTOCK FERRULE .....	7.00
SC40	SIDEPLATE .....	26.00
SC41	FRAME SPACER .....	26.00
SC43	REAR SIGHT SCREW, For Spring .....	4.00
SC44	NIPPLE .....	7.00
SC45	REAR SIGHT, Complete .....	75.00
73S280	SADDLE BAR RING .....	5.00

**NOTE: All above parts are reproduction and will require minimum finishing.**

These listed parts fit original and Yeck reproduction Smiths. We also have parts for the Italian made Smiths. Please call for availability and pricing.

## PEABODY RIFLE AND CARBINE

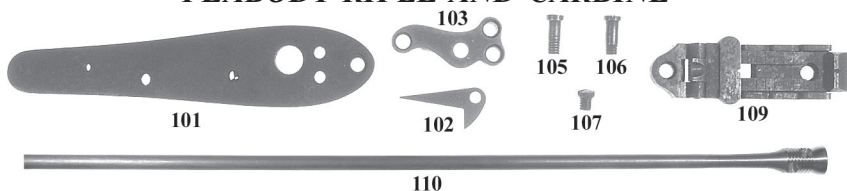

PB101	LOCKPLATE, Stripped .....	35.00
PB102	EXTRACTOR .....	10.00
PB103	BRIDLE .....	12.00
PB105	SEAR SCREW .....	3.00
PB106	BRIDLE SCREW .....	3.00
PB107	MAINSRING SCREW .....	3.00
PB109	REAR SIGHT, MILITARY RIFLE, With Spring .....	70.00
PB110	RIFLE CLEANING ROD (Reproduction) .....	45.00

## NORTH-SOUTH SKIRMISH ASSOCIATION

If you are one of the millions of Americans with an interest in Civil War or blackpowder shooting, the North-South Skirmish Association is for you. Ft. Shenandoah, the Association's home range, is located on several hundred acres of land in the rolling hills of the lower Shenandoah Valley just outside of Winchester, Va. The shooting competition in the N-SSA is done with live ammunition at both paper targets for individual score and at various breakable targets with 5 or 8 man team events. Matches are with musket, carbines, repeating rifles, revolvers, cannon and mortar. The N-SSA is comprised of regional divisions that host their own skirmishes. Twice a year, once in May and again in October, Ft. Shenandoah is host to the Association's National Skirmish. For further information visit [www.n-ssa.org](http://www.n-ssa.org)

**VISIT US ONLINE AT [WWW.SSFIREARMS.COM](http://WWW.SSFIREARMS.COM)**

Check our Website for Specials, New & Uncataloged Items.

# SPENCER

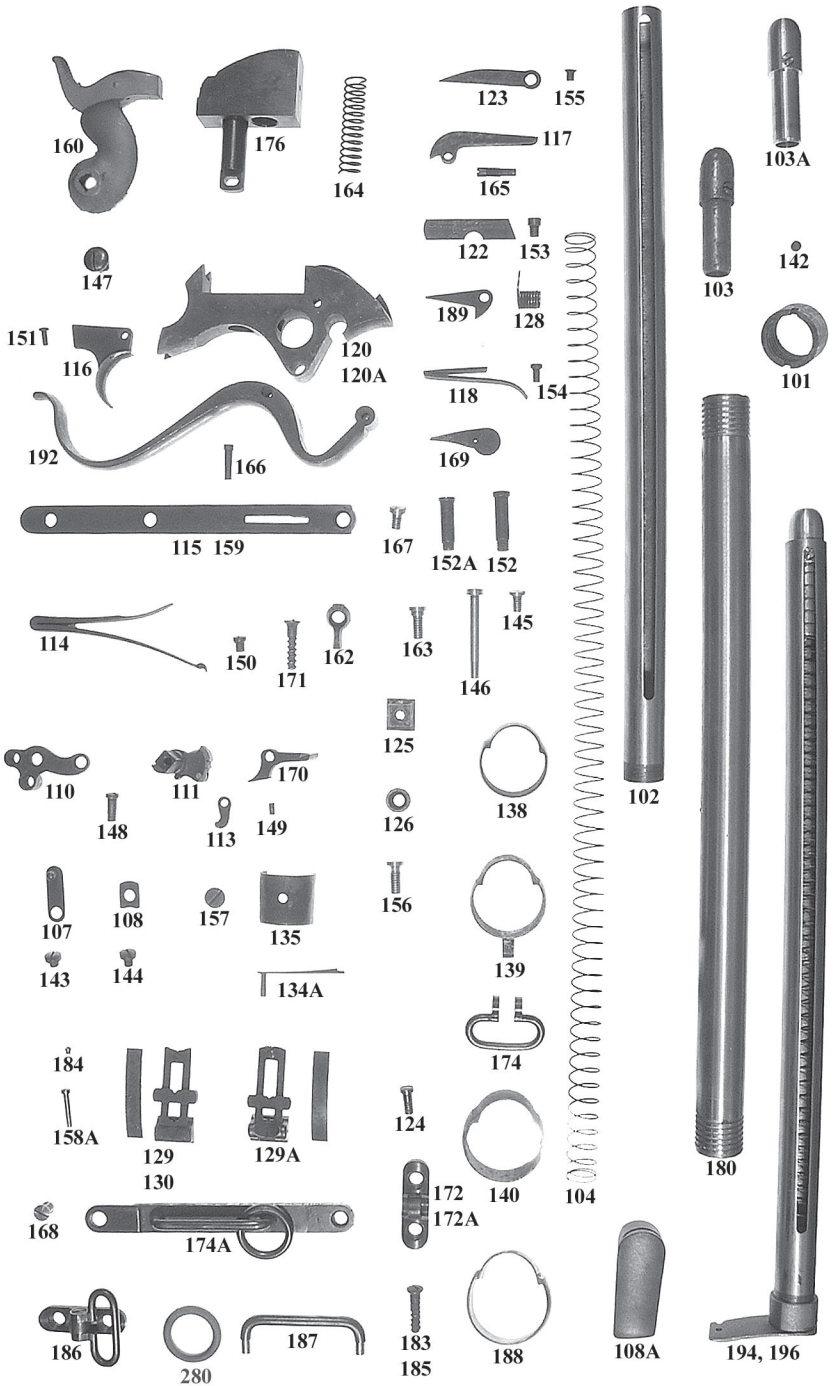



# SPENCER

GS131	BUTTSTOCK, Rifle (Reproduction) .....	125.00
GS132	BUTTSTOCK, Carbine (Reproduction) .....	125.00
GS133	FOREND, Carbine (Reproduction) .....	40.00
GS133A	FOREND, Rifle, 3 Band (Reproduction) .....	85.00
SP101	MAGAZINE TUBE NUT .....	14.00
SP102	INNER MAGAZINE TUBE (Reproduction) .....	80.00
SP103	MAGAZINE FOLLOWER .....	40.00
SP103A	MAGAZINE FOLLOWER, Centerfire Cartridge, Blunt, Cupped Face (Reproduction) .....	35.00
SP104	MAGAZINE SPRING, New Manufacture .....	12.00
SP107	MAGAZINE TUBE BASE SPRING .....	8.00
SP108	MAGAZINE TUBE BASE CATCH .....	5.00
SP108A	MAGAZINE TUBE BASE (Buttplate Trap), Rifle, Smooth (Reproduction) .....	30.00
SP110	BRIDLE .....	17.00
SP111	TUMBLER, Complete .....	80.00
SP113	TUMBLER STIRRUP .....	6.00
SP114	MAINSRING .....	60.00
SP115	TRIGGER BAR .....	35.00
SP116	TRIGGER .....	20.00
SP117	CARTRIDGE FOLLOWER (Guide) .....	30.00
SP118	CARTRIDGE FOLLOWER SPRING (Guide) .....	35.00
SP120	LOWER BREECH BLOCK, Model 1860 .....	80.00
SP120A	LOWER BREECH BLOCK, Model 1865 .....	80.00
SP122	FIRING PIN .....	8.00
SP123	EXTRACTOR .....	15.00
SP124	SLING SWIVEL PIVOT SCREW, Front And Rear .....	3.00
SP125	BARREL BLOCK .....	6.00
SP126	FORE STOCK SCREW WASHER .....	3.00
SP128	EXTRACTOR COIL SPRING .....	36.00
SP129	REAR SIGHT, M1860, Rifle and Carbine, Complete with spring .....	150.00
SP129A	REAR SIGHT, M1865, Rifle and Carbine, Complete with spring .....	150.00
SP130	REAR SIGHT, M1860, Rifle and Carbine (Reproduction) .....	85.00
SP134A	BAND SPRING (Reproduction) .....	10.00
SP135	NOSE CAP, Rifle .....	25.00
SP138	UPPER BAND, Rifle .....	35.00
SP139	MIDDLE BAND, Rifle, Without Swivel And Screw .....	55.00
SP140	LOWER BAND, Rifle .....	40.00
SP142	MAGAZINE FOLLOWER SCREW .....	4.00
SP143	MAGAZINE TUBE BASE SPRING SCREW .....	4.00
SP144	MAGAZINE TUBE BASE CATCH SCREW .....	4.00
SP145	FRONT LOCKPLATE SCREW (Reproduction) .....	7.00
SP146	REAR SADDLE BAR SCREW (Side Plate) (Reproduction) .....	7.00
SP147	HAMMER SCREW .....	10.00
SP148	BRIDLE SCREW .....	3.00
SP149	TUMBLER STIRRUP SCREW .....	3.00
SP150	MAINSRING SCREW .....	3.00
SP151	TRIGGER SCREW .....	3.00
SP152	LEVER SCREW, MODEL 1860 (Hinge Pin) .....	14.00
SP152A	LEVER SCREW, MODEL 1865 (Hinge Pin) .....	14.00
SP153	FIRING PIN SCREW .....	3.00
SP154	EXTRACTOR SPRING SCREW .....	6.00
SP155	EXTRACTOR SCREW .....	4.00
SP156	FOREND SCREW (Reproduction) .....	6.00
SP157	NOSE CAP SCREW .....	3.00
SP158A	REAR SIGHT PIVOT SCREW (Reproduction) .....	4.00
SP159	SPRINGFIELD SPENCER TRIGGER BAR .....	45.00
SP160	HAMMER, Investment Cast Steel (Reproduction) .....	38.00
SP162	STABLER CUTOFF .....	25.00
SP163	STABLER CUTOFF SCREW (Reproduction) .....	9.00
SP164	BLOCK SPRING .....	10.00
SP165	CARTRIDGE FOLLOWER (Guide) SCREW .....	8.00
SP166	BLOCK TO LEVER SCREW .....	6.00
SP167	FRONT TRIGGER BAR SCREW (Reproduction) .....	6.00
SP168	FRONT SADDLE BAR SCREW (Reproduction) .....	6.00
SP169	EXTRACTOR, Post Civil War Model .....	15.00
SP170	SEAR .....	40.00

## ***SPENCER***

SP171	BUTTPLATE WOOD SCREW .....	8.00
SP172	REAR SWIVEL BASE, Rifle .....	30.00
SP172A	REAR SWIVEL BASE (Reproduction) .....	20.00
SP174	SLING SWIVEL, Front Or Rear (Reproduction) .....	15.00
SP174A	SADDLE BAR, Original Base, Reproduction Staple and Ring .....	150.00
SP176	CENTER FIRE UPPER BREECH BLOCK. Complete. Used for conversion to center fire. Perfect for skirmisher and re-enactor .....	170.00
SP180	OUTER MAGAZINE TUBE (Stock Liner). Fully machined inside and out to assure a perfect fit to receiver, inner magazine tube and stock nut .....	85.00
SP183	SLING SWIVEL BASE WOOD SCREW .....	8.00
SP184	REAR SIGHT ELEVATION BAR RETAINING SCREW (Reproduction) .....	4.00
SP185	TRIGGER GUARD WOOD SCREW .....	8.00
SP186	REAR BUTTSTOCK SWIVEL ASSEMBLY, with Swivel, Base, Pivot Screw (Repro) .....	35.00
SP187	SADDLE BAR STAPLE .....	35.00
SP188	M1860 CARBINE BAND (Reproduction) .....	35.00
SP189	LANE PATENT EXTRACTOR, M1867 .....	20.00
SP190	LANE PATENT EXTRACTOR PIVOT SCREW .....	4.00
SP192	LEVER, FULL CASE COLORS, EXCEPTIONAL .....	195.00
SP194	MAGAZINE, COMPLETE, SMOOTH END CAP, RIFLE, BRASS REPRO FOLLOWER .....	150.00
SP196	MAGAZINE, COMPLETE, SMOOTH END CAP, RIFLE, ORIGINAL FOLLOWER .....	150.00
73S280	SADDLE BAR RING (Reproduction) .....	5.00

### ***SPENCER CONVERSION BLOCK***



**103A**



**194**

S&S FIREARMS proudly offers the following finest quality reproduction parts for the Spencer Rifle and Carbine. Parts are manufactured to insure perfect fit when utilized in the original firearm. The breechblock is machined from a solid billet of steel. BREECH BLOCK IS N-SSA APPROVED.

SP176 CENTER FIRE UPPER BREECH BLOCK. Complete. Used for conversion to center fire. Perfect for skirmisher and re-enactor ..... 170.00

NOTE: The CENTER FIRE CONVERSION BREECH BLOCK will fit 95% of all military Spencer and Burnside contract carbines and rifles without any alteration. If fitting is required, it is a minor job for a competent gunsmith. The breech block requires NO alteration to gun, simply remove original rim fire block by taking out two screws, install center fire block (a complete self contained assembly), and replace screws. The .50-70 government case, when altered, can be utilized in all military calibers and models of this arm. **Use of center fire cartridge follower (SP103A) is recommended with this conversion.**

SP103A MAGAZINE FOLLOWER, Centerfire Cartridge, Blunt, Cupped Face (Reproduction) ..... 35.00



**3**



**9**



**12**



**6**



**10**



**11**

### ***TOWER FLINT PISTOL***

*BRITISH SEA SERVICE AND DRAGOON PISTOL, CIRCA 1800-1811*

FP3	HAMMER, Without Top Jaw .....	50.00
FP6	MAINSRING .....	25.00
FP9	SEAR .....	15.00
FP10	TRIGGER, With Curl at Bottom .....	6.50
FP11	TRIGGER, Without Curl at Bottom .....	6.50
FP12	SEAR SPRING .....	15.00

## 1813/1816 NORTH

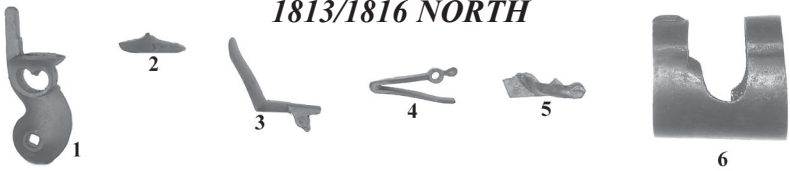

13S1	HAMMER, Flint, Repro .....	34.00
13S2	TOP JAW, Repro .....	18.00
13S3	FRIZZEN, Repro .....	32.00
13S4	FRIZZEN SPRING, Repro .....	30.00
13S5	PAN, Repro .....	27.00
13S6	FRONT BARREL BAND, Repro .....	52.00

## 1819 U.S. PISTOL

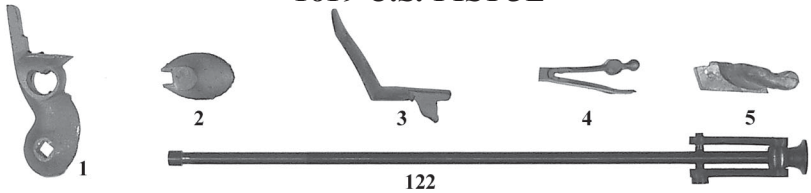

19S1	HAMMER, Repro .....	34.00
19S2	TOP JAW, Repro .....	18.00
19S3	FRIZZEN, Repro .....	32.00
19S4	FRIZZEN SPRING, Repro .....	30.00
19S5	BRASS PAN, Repro .....	27.00
JA122	RAMROD, Repro .....	45.00
GS156	WALNUT STOCK, Repro .....	85.00

## 1836 WATERS/JOHNSON PISTOLS

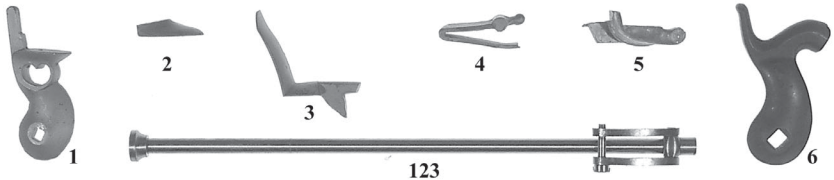

36S1	HAMMER, Repro .....	34.00
36S2	TOP JAW, Repro .....	18.00
36S3	FRIZZEN, Repro .....	32.00
36S4	FRIZZEN SPRING, Repro .....	30.00
36S5	BRASS PAN, Repro .....	27.00
36S6	PERCUSSION CONVERSION HAMMER, Repro .....	45.00
JA123	RAMROD, Repro .....	45.00
GS157	WALNUT STOCK, Repro .....	85.00

## 1842 ASTON PISTOL

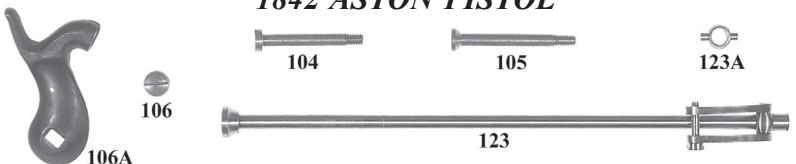

JA104	SIDEPLATE SCREW, Repro .....	6.00
JA105	TANG SCREW, Repro .....	6.00
JA106	HAMMER SCREW, Repro .....	5.00
JA106A	HAMMER, Repro .....	35.00
JA123	RAMROD, Complete With Swivel Assembly, Repro .....	45.00
JA123A	SLIDING COLLAR WITHOUT SWIVEL ARMS, Fits on ramrod, Repro .....	5.00
GS159	WALNUT STOCK, Repro .....	85.00

## **COLT BLACKPOWDER SIGNATURE SERIES**

The Following Parts Are From the Colt Signature Series Replica Revolvers. Parts Are Extremely Limited and When Sold Out Will No Longer Be Available

CBP1	DRAGOON CYLINDERS, In the White .....	20.00
CBP2	POCKET & POLICE TRIGGER/BOLT SCREW .....	3.00
CBP3	POCKET & POLICE BACKSTRAP SCREW .....	3.00
CBP4	POCKET & POLICE HAMMER SCREW .....	4.00
CBP5	POCKET & POLICE HAND & SCREW .....	7.50
CBP6	POCKET & POLICE WEDGE .....	8.00
CBP7	POCKET & POLICE LOADING LEVER LATCH PIN .....	2.00
CBP8	POCKET & POLICE LOADING LEVER LATCH SPRING .....	2.00
CBP9	1851 NAVY PLUNGER SCREW .....	3.00
CBP10	1851 NAVY & 1860 ARMY LOADING LEVER LATCH .....	5.00
CBP11	1847 WALKER HAMMER .....	15.00
CBP12	1847 WALKER BACKSTRAP SCREW .....	3.00
CBP13	1847 WALKER HAMER SCREW .....	4.00
CBP14	PATTERSON LOADING LEVER .....	35.00
CBP15	PATTERSON GRIP SCREW .....	3.00
CBP16	PATTERSON HAMMER PIN .....	2.00
CBP17	PATTERSON LOADING LEVER CATCH .....	12.00
CBP18	PATTERSON CYLINDER STOP SCREW .....	3.00
CBP19	PATTERSON LOADING LEVER SCREW .....	3.00
CBP20	PATTERSON BACK FRAME SCREW .....	4.00
CBP21	PATTERSON NIPPLE .....	2.50
CBP22	PATTERSON FIRING PIN RETAINING PIN .....	2.00
CBP23	PATTERSON TRIGGERGUARD SCREW .....	4.00
CBP24	PATTERSON TRIGGER STOP SCREW .....	6.00
CBP25	1862 TRAPPER BRASS BULLET SEATER, Pocket Police Variant .....	4.00

## **STARR REVOLVER**

SR3	TAKEDOWN SCREW, ALL MODELS, Repro .....	9.00
SR7	TRIGGER RETURN SPRING, REAR, DOUBLE ACTION, Repro .....	22.00
SR8	TRIGGER RETURN SPRING, FRONT, DOUBLE ACTION, Repro .....	22.00
SR10	TRIGGER SET, Repro .....	25.00
SR20	GRIPS, One Piece Walnut, Requires Final Fitting, Repro .....	42.00
BKA231	STARR REVOLVER SERVICE AND REPAIR, Please consult book section for additional details	

## **VIRGINIA DRAGOON REVOLVER**

The Following Parts Are For The 1970's Virginia Dragoon Series Single Action Revolvers

VAD1	7 1/2" BARREL, .41 Magnum, New but with Storage Rust .....	10.00
VAD2	TRIGGERGUARD/BACKSTRAP .....	3.00
VAD3	HAMMER .....	5.00
VAD4	EJECTOR ROD, With Thumbpiece .....	5.00
VAD5	FRONT SIGHT .....	2.00
VAD6	LOADING GATE .....	5.00
VAD7	LOADING GATE SPRING .....	1.00
VAD8	HAND .....	3.00
VAD8-R	HAND, Storage Rust .....	6 For 5.00
VAD9	EJECTOR TUBE SCREW .....	10 For 5.00
VAD10	REAR SIGHT BASE .....	2.00
VAD11	HAMMER SCREW .....	3.00
VAD12	TRIGGER SCREW .....	3.00

## **REPLICA ARMS PISTOL PARTS**

The Following Parts are for the 1970's Replica Arms Repro Pistols

RAH01	1847 WALKER LOADING LEVER WITH CATCH .....	40.00
RAH02	1847 WALKER HAMMER .....	30.00
RAH03	1847 WALKER MAINSPRING .....	20.00
RAH04	1858 REMINGTON .44 HAMMER .....	20.00

## **WINCHESTER HOTCHKISS**

MP228	WINCHESTER HOTCHKISS EXTRACTOR .....	50.00
MP257	WINCHESTER HOTCHKISS SAFETY CUTOFF (Repro) .....	95.00

## **RAMRODS**

HL4	HALL RIFLE .....	42.00	58S204	MUSKET, Brass, 33" .....	22.00
17C1	M1817 COMMON RIFLE .....	45.00	58S205	CARBINE, Brass, 25" .....	22.00
16S20	1816 SPRINGFIELD .....	40.00	58S205A	CARBINE, Steel, 25" .....	30.00
41S101	1841 MISSISSIPPI, Brass Tip .....	45.00	ASM13	1842 SPRINGFIELD, Armi-Sport ..	40.00
41S101A	1841 MISSISSIPPI, Brass .....	30.00	ASM49	ENFIELD, 3 Band, Armi-Sport .....	42.00
41S102	1841 MISSISSIPPI, Steel .....	45.00	ECB100	COOK & BROTHERS, Euroarms ..	42.00
42S27	1842 SPRINGFIELD .....	40.00	EEM30	ENFIELD, Euroarms .....	42.00
42S28	1842 SPRINGFIELD, Cupped .....	40.00	EEM3324	ENFIELD, Musketoon .....	42.00
51S2	1851 CADET RAMROD .....	45.00	EEM3330	ENFIELD, 2 Band .....	42.00
58S127	1855/61 SPRINGFIELD, 3 Band .....	45.00	EEM3930	ENFIELD, 3 Band .....	42.00
58S127A	1855 SPRINGFIELD, 2 Band .....	45.00	EN68	ENFIELD, Brass 40" .....	22.00
58S215	1855 SPRINGFIELD, 33" .....	30.00	EN69	ENFIELD, Brass 33" .....	22.00
58S179	1863-64 SPRINGFIELD, 2 Band .....	30.00	EN70	ENFIELD, Brass 26" .....	22.00
58S180	1863-64 SPRINGFIELD, 3 Band .....	30.00	ESP34	SPRINGFIELD, Euroarms .....	45.00
58S203	MUSKET, Brass, 40" .....	22.00	PB110	PEABODY RIFLE .....	45.00

## **CLEANING RODS**

68S137	M1868 SPRINGFIELD .....	45.00	K600	KRAG RIFLE, 3 Piece .....	50.00
68S137A	M1870 SPRINGFIELD .....	45.00	MP258	SWISS VETTERLI .....	45.00
73S297	TRAPDOOR CARBINE, 3 Piece .....	50.00	PB110	PEABODY RIFLE .....	45.00
73S326	M1873 SPRINGFIELD 1st Type .....	45.00	RB300	ROLLING BLOCK, Argentine .....	45.00
73S327	M1873 SPRINGFIELD 2nd Type .....	45.00	RB300	ROLLING BLOCK, 43 Spanish .....	45.00
73S328	M1884 SPRINGFIELD .....	45.00	RB301	ROLLING BLOCK, 1868 Danish ..	45.00
RL110	REMINGTON LEE .....	45.00	RB302	ROLLING BLOCK, NYS 50/70 .....	45.00

*The Above Ramrods and Cleaning Rods are Reproduction*

## **RIFLE SLINGS**

L12	CIVIL WAR SPRINGFIELD MUSKET SLING. Leather. Natural Color With Brass Adjusting Hook And Sewn Keepers .....	18.00
L13	CIVIL WAR ENFIELD MUSKET SLING. Leather. Natural Color With Brass Adjusting Hook and Sewn Keepers .....	18.00
L25	.45/70 TRAPDOOR SPFLD. SLING. Leather W/Brass Claw, Button, Leather Keepers .....	25.00
L26	.30/40 US KRAG SLING. Leather W/Brass Claw, Button, Leather Keepers .....	25.00
L36	CIVIL WAR HENRY RIFLE SLING. Natural bridle leather, Oil finished. Brass attaching button, Brass adjusting slide and blued steel attaching hook. Embossed marking reads "Henry's Repeating Rifle, Patented Oct 16, 1860" in rectangle .....	35.00
L50	CANVAS MUSKET SLING, Repro .....	20.00
L56	1903 SPRINGFIELD LEATHER SLING, Repro .....	25.00
L60	K98 MAUSER SLING, Repro .....	25.00
LN34	LEE NAVY SLING, with Hardware and Detachable Swivel. Repro .....	65.00

## **SHOOTERS SIGHTS**

58S120	TALL FRONT SIGHT, Radius Base, Solders on Barrel, Fits 1855 Rifle .....	15.00
58S120A	TALL FRONT SIGHT, Dovetail, Fits 1855 Rifle .....	24.00
58S147	"L" LEAF, Fits 1855-1864 Muskets .....	14.00
58S148	TALL FRONT SIGHT, Radius Base, Solders on Barrel, Fits 1855-1864 Muskets .....	15.00
58S148A	TALL FRONT SIGHT, Dovetail, Fits 1855-64 Muskets .....	24.00
73S349	TRAPDOOR CARBINE TALL FRONT SIGHT BLADE .....	15.00
73S351	TRAPDOOR RIFLE TALL FRONT SIGHT BLADE .....	15.00
K527A	KRAG TALL FRONT SIGHT BLADE .....	15.00
03S8	1903 SPRINGFIELD FRONT SIGHT BLADE, USMC style .....	32.00
03S8A	1903 SPRINGFIELD REAR SIGHT SLIDE USMC SPECS, Use With 03S8 .....	38.00
JA182	PISTOL FRONT SIGHT Fits Into Dovetail, .540" Tall x .090" wide. ....	18.00
HRAXX2	HENRY FRONT SIGHT, Competition Height, .082" Wide .....	17.00
HRAXX6	HENRY "L" SHAPED SLIDE, Replaces Factory Slide & Provides Two Peep Positions .....	25.00
HRAXX7	HENRY BRASS FRONT SIGHT BLASDE, Competition Height, .090" Wide .....	17.00
BN106	BURNSIDE TALL FRONT SIGHT .....	15.00
MY222	MAYNARD FRONT SIGHT, EXTRA HIGH, .100 WIDE .....	16.00
MY223	MAYNARD FRONT SIGHT, EXTRA HIGH, .050 WIDE .....	16.00
SC11	SMITH CARBINE FRONT SIGHT, One piece, extra high, fits dovetail .....	20.00
SC36A	SMITH CARBINE FRONT SIGHT BLADE, .094 Thick .....	6.50
SC36B	SMITH CARBINE FRONT SIGHT BLADE, .075 Thick .....	6.50
SC36C	SMITH CARBINE FRONT SIGHT BLADE, .062 Thick .....	6.50

*The Above Sights are Reproduction*

# GUNSTOCKS

The Following Stocks Are All Reproduction Unless Otherwise Noted

GS101	M1816 SPRINGFIELD MUSKET .....	275.00
GS102	M1842 SPRINGFIELD MUSKET .....	275.00
GS103	REPLACEMENT FOREND SECTION FOR CUTDOWN M1816/1842 .....	45.00
GS104	1841 MISSISSIPPI .....	275.00
GS104A	1841 MISSISSIPPI FOREND SECTION .....	45.00
GS105	M1855 SPRINGFIELD RIFLE (2 BAND) With Patchbox Inlet .....	275.00
GS106	M1855 SPRINGFIELD RIFLE (2 BAND) forend section .....	45.00
GS107	M1855 SPRINGFIELD RIFLE MUSKET (3 BAND) With Patchbox Inlet .....	275.00
GS108	M1855 SPRINGFIELD RIFLE MUSKET (3 BAND) W/O Patchbox Inlet .....	275.00
GS109	M1861/63 SPRINGFIELD MUSKET (3 BAND) .....	275.00
GS110	M1861 SPECIAL MODEL MUSKET, COLT, L.G.Y., Amoskeg .....	275.00
GS111	REPLACEMENT FOREND SECTION FOR CUTDOWN M1855/61, 1861 SPEC .....	40.00
GS112	M1863 WHITNEYVILLE PLYMOUTH RIFLE .....	275.00
GS113	M1863 REMINGTON ZOUAVE RIFLE .....	275.00
GS114	C.S. FAYETTEVILLE RIFLE .....	275.00
GS115	C.W ENFIELD MUSKET (3 BAND) .....	275.00
GS115A	C.W ENFIELD MUSKET FOREND SECTION(3 BAND) .....	45.00
GS116	C.W ENFIELD MUSKET (2 BAND) .....	275.00
GS117	SLANT BREECH SHARPS CARBINE BUTTSTOCK With Patchbox Inlet .....	115.00
GS118	SLANT BREECH SHARPS CARBINE BUTTSTOCK Without Patchbox Inlet .....	115.00
GS119	SLANT BREECH SHARPS CARBINE FOREND .....	65.00
GS120	M1859 SHARPS CARBINE BUTTSTOCK With Patchbox Inlet .....	110.00
GS121	M1863 SHARPS CARBINE BUTTSTOCK Without Patchbox Inlet .....	110.00
GS122	M1859/1863 SHARPS RIFLE BUTTSTOCK With Patchbox Inlet .....	110.00
GS123	M1859/1863 SHARPS CARBINE FOREND .....	40.00
GS124	M1859/1863 SHARPS RIFLE FOREND .....	85.00
GS124A	SHARPS RIFLE FOREND, 36 INCH MODEL .....	85.00
GS125	1st MODEL MAYNARD BUTTSTOCK With Patchbox Inlet .....	75.00
GS126	2nd MODEL MAYNARD BUTTSTOCK .....	65.00
GS126A	M1882 MAYNARD FOREND, For #16, can be fitted to others .....	40.00
GS127	C.W. BALLARD BUTTSTOCK, With Top & Lower Tang Inletting. 11 1/4" OAL, Repro .....	65.00
GS127A	BROWN OR MERRIMACK BALLARD BUTTSTOCK , 11" OAL (Reproduction) .....	65.00
GS127B	BALLARD BUTTSTOCK, Postwar, 12" OAL (Reproduction) .....	65.00
GS128	C.W. BALLARD RIFLE FOREND (3 BAND) .....	50.00
GS128A	C.W. BALLARD CARBINE FOREND .....	42.00
GS129	C.W. STARR CARBINE BUTTSTOCK .....	60.00
GS130	C.W. STARR CARBINE FOREND .....	40.00
GS131	SPENCER RIFLE BUTTSTOCK .....	125.00
GS132	SPENCER CARBINE BUTTSTOCK .....	125.00
GS133	SPENCER CARBINE FOREND .....	40.00
GS133A	SPENCER RIFLE FOREND .....	85.00
GS134	BURNSIDE CARBINE BUTTSTOCK .....	65.00
GS135	BURNSIDE CARBINE FOREND .....	40.00
GS136	C.W. GALLAGHER CARBINE BUTTSTOCK .....	60.00
GS138	C.W. SMITH CARBINE BUTTSTOCK .....	110.00
GS139	C.W. SMITH CARBINE FOREND .....	42.00
GS140	M1874 SHARPS RIFLE BUTTSTOCK Without Patchbox Inlet .....	110.00
GS141	M1874 SHARPS RIFLE BUTTSTOCK W/Patchbox and D.S.T Inlet. ....	125.00
GS142	M1873 TRAPDOOR CARBINE (EARLY) .....	235.00
GS143	M1873 TRAPDOOR CARBINE (LATE) .....	235.00
GS144	M1873 TRAPDOOR RIFLE .....	275.00
GS145	REPLACEMENT FOREND SECTION FOR CUTDOWN TRAPDOOR RIFLES 45/70 .....	45.00
GS145C	REPLACEMENT FOREND SECTION FOR CARBINE, fully shaped, inlet for bandspring ..	45.00
GS146	M1892 KRAG RIFLE STOCK .....	275.00
GS147	REPLACEMENT FOREND SECTION FOR CUTDOWN KRAG RIFLES .....	45.00
GS148	M1895 WINCHESTER LEE STRAIGHT PULL STOCKS .....	275.00
GS148A	M1895 WINCHESTER LEE STRAIGHT PULL REPLACEMENT FOREND SECTION .....	50.00
GS149	REM. ROLLING BLOCK BUTT 1871 ARMY MODEL. Can be fitted to others .....	60.00
GS149A	REM. ROLLING BLOCK FOREND, .43 Spanish 3 Band, 29.5" Long, Adaptable to Others ..	50.00
GS150	M1886 45/70 TRAP DOOR EXP. CARB. Requires final forend shaping .....	275.00
GS151	M1863 CS RICHMOND CARBINE .....	275.00
GS152	M1870 50/70 TRAPDOOR RIFLE. Can also be used for M1868 .....	275.00
GS160	M1841, M1851 CADET STOCK .....	275.00
GS164	1903 SPRINGFIELD "C" PISTOL GRIP STOCK .....	275.00

## **GUNSTOCKS**

GS165	M66,68,70 CADET STOCK .....	275.00
GS166	M14-M1A STOCK – Original U.S. Surplus, Used, Small nicks, scratches. Limited qty .....	40.00
GS167	1809 POTSDAM STOCK. Available in Beech, Maple, European Walnut, specify .....	275.00
GS167A	1809 POTSDAM FOREND SECTION. Used in the repair of cutdown/cutoff stocks .....	75.00
GS168	AUSTRIAN LORENZ STOCK, BEECH .....	275.00
GS168A	AUSTRIAN LORENZ FOREND SECTION. Used in the repair of cutdown/cutoff stocks .....	75.00
GS170	SHARPS & HANKINS BUTTSTOCK .....	60.00
GS171	COLT LIGHTNING BUTTSTOCK .....	60.00
GS172	MERRILL CARBINE STOCK, 1 <sup>st</sup> Model, with Patchbox Inlet .....	175.00
GS172A	MERRILL CARBINE STOCK, 2 <sup>nd</sup> Model, without Patchbox Inlet .....	175.00
GS174	CIVIL WAR JOSLYN CARBINE STOCK .....	175.00

## **PISTOL STOCKS**

GS155	M1813/1816 PISTOL STOCK .....	85.00
GS156	M1819 PISTOL STOCK .....	85.00
GS157	M1836 PISTOL STOCK .....	85.00
GS158	M1843 US AMES NAVY PISTOL STOCK .....	85.00
GS159	M1842 PISTOL STOCK .....	85.00

## **REPRODUCTION BARRELS**

THE FOLLOWING BARRELS ARE N-SSA APPROVED & ARE AVAILABLE WITH OR WITHOUT FRONT AND REAR SIGHTS. THEY HAVE THREE LANDS AND GROOVES WITH PROGRESSIVE DEPTH RIFLING. AVAILABLE IN .577 OR .580 BORE DIAMETER. BARRELS ARE NOT DOVETAIL CUT, DRILLED OR THREADED FOR SIGHT MOUNTING SCREW. THIS IS AVAILABLE FOR A NOMINAL CHARGE OF \$30.00. SPECIFY REAR SIGHT YOU ARE USING. DOVETAILED FRONT SIGHT WITH INSTALLATION \$45.00, ORIGINAL STYLE FIXED FRONT SIGHT \$20.00 PLUS COST OF SIGHT. PRICES ARE FOR BARRELS WITHOUT SIGHTS. COMPLETE WITH BREECHPLUG, NIPPLE AND CLEANOUT SCREW IF REQUIRED.

BRL01	1855-61 Springfield. 3 Band Length, 40" .....	325.00
BRL02	1855-61 Springfield. 2 Band Length, 33" (Artillery Model) .....	310.00
BRL03	1855 Rifle (Heavy Barrel), 33" .....	310.00
BRL04	Richmond Carbine, 25" .....	290.00
BRL05	1863 Springfield. 3 Band Length, 40" .....	325.00
BRL06	1863 Springfield. 2 Band Length, 33" (Artillery Model) .....	310.00
BRL07	1842 Springfield. .69 Cal. Rifled, 3 Band Length .....	345.00
BRL08	1842 Springfield. .69 Cal. Smooth Bore, 3 Band Length .....	330.00
BRL09	1842 Springfield. .69 Cal. Smooth Bore, 2 Band Length .....	325.00
BRL10	1841 Mississippi .54 Cal. 6 land and groove .....	320.00
BRL11	1861 Special Manufactured to fit reproduction firearms, 3 Band Length .....	325.00
BRL11	1861 Special Manufactured to fit reproduction firearms, 2 Band Length .....	310.00

## **45/70 TRAPDOOR BARRELS**

BRL4570 1873-1889 .45/70 U.S. Springfield Trapdoor Carbine Barrels with receiver and ejector stud. Reworked original Springfield rifle barrels to correct Carbine length and taper. Correct reproduction front sight on M1873 and correct Carbine front sight base installed on later Models. Original Armory proof marks remain. Offered in the white, easily blued or browned (see SA129, SA130). Since these are original Springfield Armory Rifle barrels that have been in service, bore condition will vary from barrel to barrel. Please check with us on availability of models and bore condition. Priced from ..... 150.00 to 325.00.

## **GARAND ACCESSORY POUCH**

D39347 Government Designation: Pouch, Web, ACCY, Rifle, U.S., Caliber .30, M1. DWG D39347 ISN-B21-02-24. Issued with the M1 Garand to hold combination tool and oiler, brush and thong assembly. The 4 1/8 by 8 1/4 waterproofed cloth pouch has rounded flap with single snap closure and was carried in the knapsack. Unissued condition, Rare ..... 7.00 ea  
SPECIAL - 4 pouches for 20.00



**VISIT US ONLINE AT [WWW.SSFIREARMS.COM](http://WWW.SSFIREARMS.COM)**

Check our Website every December for Christmas Specials.

## **MISCELLANEOUS GUN PARTS**

MP204	JACOBS CAPE RIFLE LEFT HAND MAINSPRING .....	15.00
MP206	U.S. ROBERTS CONVERSION PERCUSSION HAMMER, M1863 .....	30.00
MP206A	ROBERTS CONVERSION DETENTED INDICATING ARM, Mounts on left of Breech .....	25.00
MP216	REMINGTON 1863 ZOUAVE FRONT SIGHT, Tall for Competition (Reproduction) .....	15.00
MP216A	ZOUAVE REAR SIGHT LEAF, L Shaped for Competition (Reproduction) .....	14.00
MP217	REMINGTON 1863 ZOUAVE RAMROD, 32.5 INCHES (Reproduction) .....	30.00
MP218	WWII CARCANO FRONT BAND .....	8.00
MP219	WWII CARCANO BAYONET LUG .....	8.00
MP221	EUROPEAN LADDER REAR SIGHT, Suitable For Sporterized conversions .....	25.00
MP222	VICKERS RUSSIAN CONTRACT MACHINEGUN TRIGGER PULL GAUGE .....	50.00
MP223	GERMAN LUGER GRIP SCREW (Repro) .....	4.00
MP225	SCREWDRIVER BLADE FOR AUSTRIAN MUSKET TOOL, Original CW Issue .....	8.00
MP227	CHAFEE-REESE BOLT RETAINER (Bushing) .....	25.00
MP229	M1763-66 CHARLEVILLE & 1795 SPRINGFIELD BRIDLE (Reproduction) .....	9.00
MP230	GREENE UNDERHAMMER MUSKET MAINSPRING, Original .....	90.00
MP234	FRONT SIGHT, TRIANGULAR STYLE, 5/16 Slot, Popular 1870'S - 1900 Style, Original .....	15.00
MP237	USN DRILL SHELL BARREL, Sub caliber, Used in 6 Pounder, .45/70 Caliber, Barrel Only .....	75.00
MP238	STEVENS #44 MAINSPRING (Reproduction) .....	27.00
MP239	LEE ENFIELD MARK 1 LONG RANGE REAR SIGHT (Reproduction) .....	15.00
MP240	M1830 SPRINGFIELD CADET Top Band .....	1250.00
MP242	M1881 TRAPDOOR SPRINGFIELD FORAGER SHOTGUN BREECHBLOCK. Dated 1881, Much Case Hardening Colors. Complete Assembly .....	450.00
MP244A	NEEDHAM FIRING PIN, One Piece Casting, Short Nose Pin (Reproduction) .....	48.00
MP244B	NEEDHAM FIRING PIN, One Piece Casting, Long Nose Pin (Reproduction) .....	48.00
MP247	M1 GARAND FOLLOWER SHOULDER PIN (Reproduction) .....	4.00
MP248	REAR SIGHT FOR 44/60 PIEDMONTSE RIFLE-MUSKET (Original) .....	75.00
MP250	MAUSER RIFLE REAR SIGHT LADDER WITH ELEVATION BAR .....	10.00
MP251	1888 GERMAN MAUSER CARBINE REAR SIGHT, Complete .....	30.00
MP252	REMINGTON KEENE CARTRIDGE LIFTER .....	135.00
MP253	REMINGTON KEENE CARTRIDGE LIFTER RELEASE LATCH .....	45.00
MP254	REMINGTON KEENE CARTRIDGE LIFTER RELEASE LATCH SPRING .....	35.00
MP255	STEVENS 1 1/2 EXT. Pin type mount, not center screw .....	25.00
MP256	BRAZILIAN LIGHT MINIE RIFLE LONG RANGE REAR SIGHT (Reproduction) .....	85.00
MP257	J. KRIDER CIVIL WAR RIFLE SIGHT (Reproduction) .....	85.00
MP258	SWISS VETTERLI CLEANING ROD .....	45.00

## **MISCELLANEOUS PISTOL PARTS**

JA107	NICKLE SILVER GRIP ESCUTCHEON, Remington Pattern, Pair .....	6.00
JA109	COOPER REVOLVER, HAND & SPRING, Original .....	18.00
JA110	COOPER REVOLVER TRIGGER SPRING, original .....	18.00
JA111	WHITNEY REVOLVER BOLT, ORIGINAL .....	30.00
JA116	SHARPS PEPPERBOX BARREL RELEASE LEVER WITHOUT SPRING .....	40.00
JA116A	SHARPS 4 BARREL FRAME SCREW, (Original) .....	8.00
JA117	SHARPS AND HANKINS DERRINGER MAINSPRING, Large Frame .....	25.00
JA118	SHARPS AND HANKINS DERRINGER MAINSPRING, Small Frame .....	25.00
JA119	REMINGTON BEALS HAND & SPRING .....	50.00
JA120	REMINGTON BEALS CYLINDER BOLT .....	50.00
JA123A	SLIDING COLLAR WITHOUT SWIVEL ARMS, Fits on ramrod (Repro) .....	5.00
JA137	SAVAGE NAVY REVOLVER LOADING LEVER ASSEMBLY, Complete (Repro) .....	170.00
JA142	UBERTI REVOLVER NIPPLES, 6 piece set .....	12.00
JA143	COLT EARLY MODEL PATTERSON STYLE REVOLVER CYLINDER, .36 Cal, With all 5 nipples, Serial Numbered 40 .....	10,500.00
JA144	BUTTERFIELD ARMY MODEL REVOLVER CYLINDER, .41 Cal, With all 5 nipples, Serial Numbered 97. Standard Model with teardrop Shape notches .....	700.00
JA182	PISTOL FRONT SIGHT FOR COMPETITIVE SHOOTING, Fits Into Dovetail, .540" Tall x .090" wide. Fully Machined And Blued .....	18.00
JA184	C.W. COOPER D/A REVOLVER CYLINDER LOCK, Original .....	30.00
BKA274	BASIC CAP AND BALL REVOLVER SERVICE, See Book Section For Complete Description	

**Most Above Parts & Stocks are Reproduction Unless Otherwise Noted**

**VISIT US ONLINE AT [WWW.SSFIREARMS.COM](http://WWW.SSFIREARMS.COM)**

Check our Website for Specials, New & Uncataloged Items.